



# Implantium II

## Product Catalog

**Dentium**  
For Dentists By Dentists

**Implantium II**

*A New Choice*

*For the Customer*



# Contents

## Introduction

Implantium II Characteristics	06
Implantium II Color Coding by Diameter	08
Implantium II Fixture [CaP Coating]	09
Implantium II Fixture [S.L.A. Surface]	10

## Surgical Components

Cover Screw	11
Healing Abutment	12

## Prosthetic Procedure 1

Dual / Combi Abutment - Abutment Level Impression	14
Combi Abutment	15
Dual Abutment [Hex]	16
Dual Abutment [Non-hex]	17
Abutment Level Impression Components	18
Restorative Kit	19

## Prosthetic Procedure 2

Dual / Custom / Dual Milling / Angled / Direct-Casting / Metal-Casting / Temporary (Plastic & Ti) Abutment - Fixture Level Impression	20
Fixture Level Impression Components	21
Custom Abutment	23
Dual Milling Abutment	24
Angled Abutment [15°]	26
Angled Abutment [25°]	27
Direct-Casting Abutment	28
Metal-Casting Abutment	28
Temporary Abutment	29

## Prosthetic Procedure 3

Screw Abutment - Abutment Level Impression	30
Screw Abutment	31
Angled Screw Abutment	32
Screw Abutment Impression Components	33

## Prosthetic Procedure 4

Overdenture Procedure	
- Positioner / Mini Ball / Magnetic Attachment	36
Positioner Attachment	37
Mini Ball Attachment	39
Magnetic Attachment [Dome Type]	40
Magnetic Attachment [Flat Type]	41

## Instruments

Surgical Kit [Full]	42
Surgical Kit [Standard]	43
Drill Stopper Kit	44
Drill	45
Stopper	49
Instrument	51
DASK	52
Sinus Bur Kit / Sinus Kit	53
DASK / Sinus Bur Kit / Sinus Kit	54
Osteotome Kit	56
Trephine Kit	57
Prosthetic Kit	58
Planning Kit	59
Prosthetic and Laboratory Instrument	60
Help Kit	62



## CaP Coating

- Allows faster rate of cell adhesion
- Achieve primary stability of surrounding bone earlier after initial implant placement



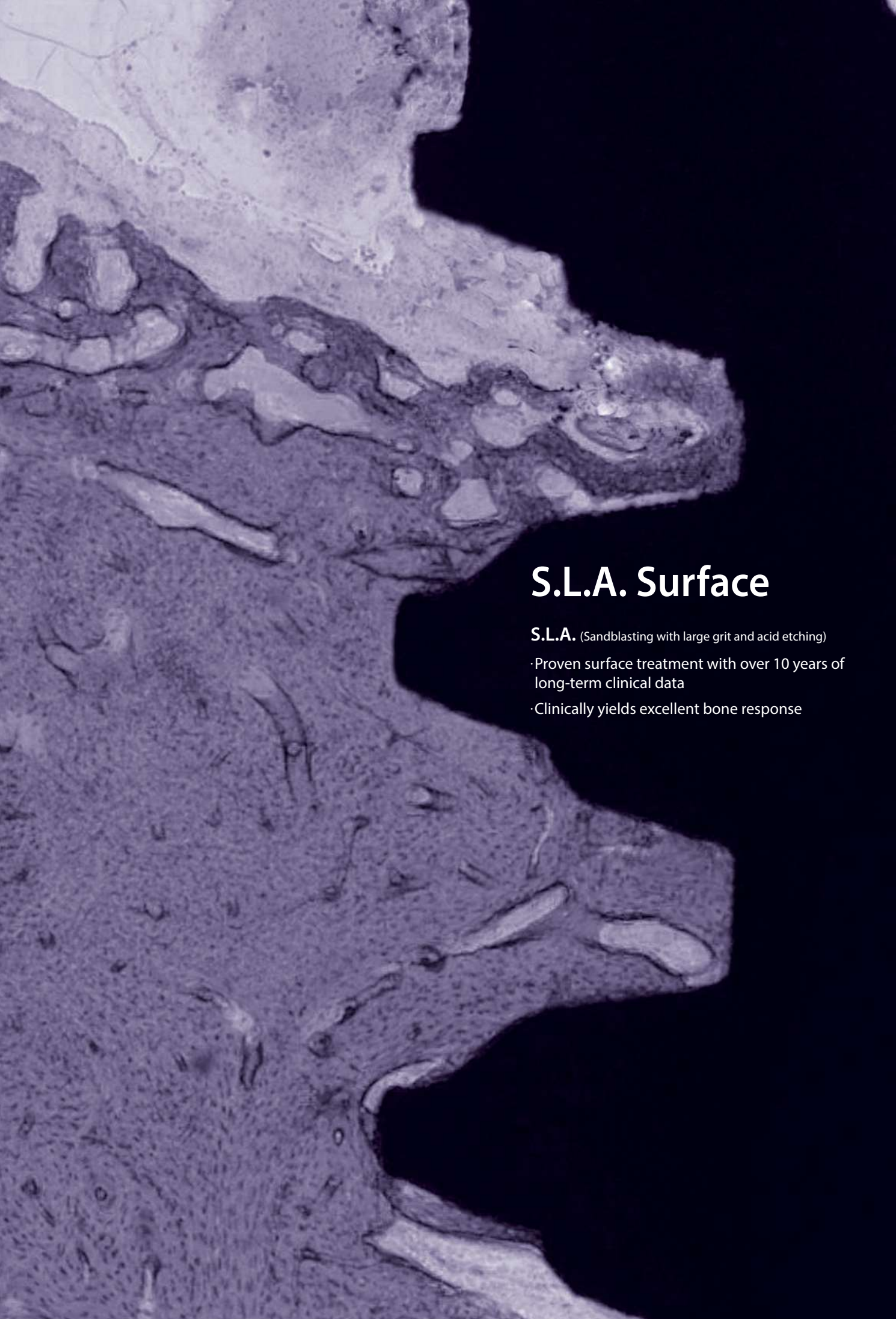

## S.L.A. Surface

**S.L.A.** (Sandblasting with large grit and acid etching)

- Proven surface treatment with over 10 years of long-term clinical data
- Clinically yields excellent bone response

# Implantium II Characteristics



## CaP Coating

- Allows faster rate of cell adhesion
- Achieve primary stability of surrounding bone earlier after initial implant placement

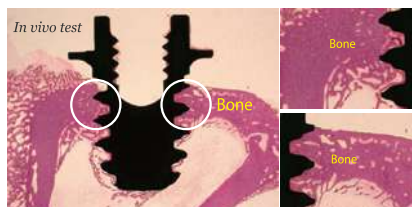

The application of a thin film of CaP on S.L.A. surface yielded better results in osseointegration during in vivo test

## S.L.A. Surface

- Proven surface treatment with over 10 years of long-term clinical data
- Clinically yields excellent bone response

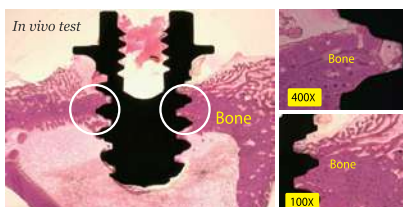

# Implantium II Characteristics

## A Extended Cutting Edge



- Improved self-tapping ability
- Allows more control over the depth of fixture placement
- Alleviates the occurrence of over-torque during placement in dense bone

## B Bacteria Resistant Bevel

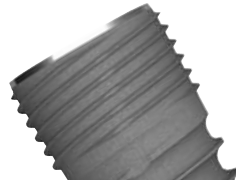

- The tapered bevel platform design may make bone profiling unnecessary at 1st, 2nd surgery.

## C Biological Connection



- The conical hex connection between implant and abutment interface ensures hermetic sealing.
- The biologic connection distributes the load to the fixture evenly. Therefore it helps minimize micro-movement and marginal bone loss.
- All implant diameters share the same internal hex.

## D Biological Connection

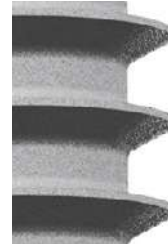

- Thread platform design creates excellent bone to implant contact.
- Threads engage and penetrate bone with ease.

## E Quadruple & Double thread Design

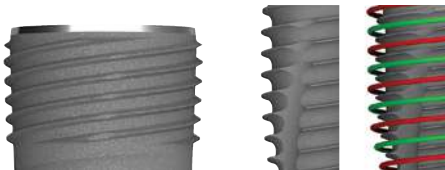

- Chair time decreased through faster fixture placement

## F Optimal Fixation Threads

- Greater advantage for Immediate and Early Loading
- Enhanced initial stability through longer and sharper threading

## G Maintained Compatibility









- Prosthetic components and Surgical Kit 100% compatible with the existing Implantium II Implant System

# Implantium II Color Coding by Diameter

## Color Coding by Diameter

• Cover screw is not included.

(Unit: mm)

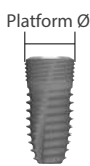
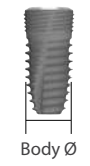
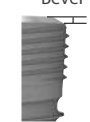
<b>Cap Color</b>					
		Yellow	Green	Blue	Red
<b>Fixture Implantium II (Mount Free)</b>					
 Platform Ø	Fixture Platform Diameter	3.7	4.0	4.5	5.0
 Body Ø	Fixture Body Diameter	3.6	4.0	4.5	5.0
 Bevel	Fixture Bevel Height	0.2	0.1	0.3	0.4



# Implantium II Fixture [CaP Coating]

Unit: mm, Scale 1 : 1.5

## Platform Ø 3.7 | Body Ø 3.6

L	Art. No.
8	FXI 36 08 P
10	FXI 36 10 P
12	FXI 36 12 P
14	FXI 36 14 P

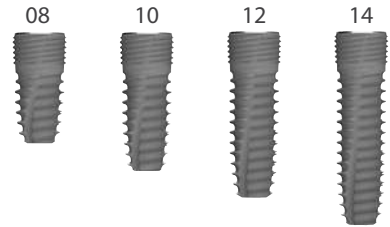
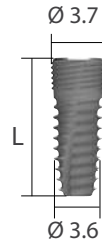

## Platform Ø 4.0 | Body Ø 4.0

L	Art. No.
8	FXI 40 08 P
10	FXI 40 10 P
12	FXI 40 12 P
14	FXI 40 14 P

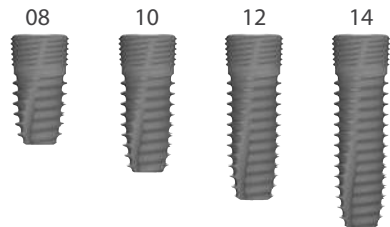

## Platform Ø 4.5 | Body Ø 4.5

L	Art. No.
8	FXI 45 08 P
10	FXI 45 10 P
12	FXI 45 12 P
14	FXI 45 14 P

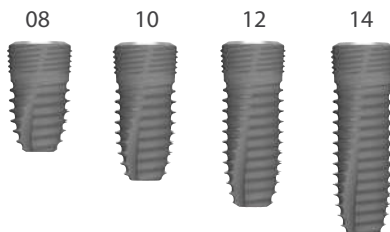

## Platform Ø 5.0 | Body Ø 5.0

L	Art. No.
8	FXI 50 08 P
10	FXI 50 10 P
12	FXI 50 12 P
14	FXI 50 14 P

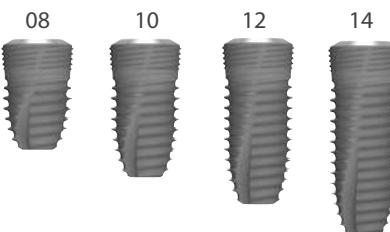

※ Note: To prevent damage to the Implant driver or fixture, do not over torque during fixture insertion

# Implantium II Fixture [S.L.A. surface]

Unit: mm, Scale 1 : 1.5

## Platform Ø 3.7 | Body Ø 3.6

L	Art. No.
8	FXI 36 08
10	FXI 36 10
12	FXI 36 12
14	FXI 36 14

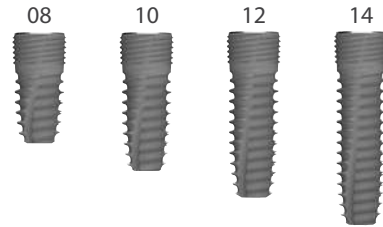
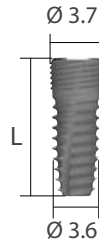

## Platform Ø 4.0 | Body Ø 4.0

L	Art. No.
8	FXI 40 08
10	FXI 40 10
12	FXI 40 12
14	FXI 40 14

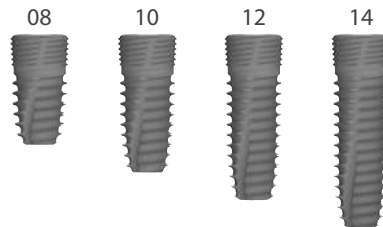

## Platform Ø 4.5 | Body Ø 4.5

L	Art. No.
8	FXI 45 08
10	FXI 45 10
12	FXI 45 12
14	FXI 45 14

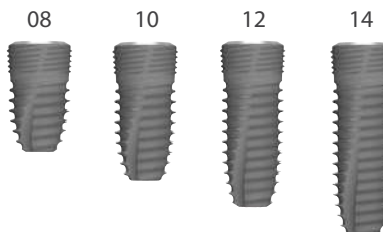

## Platform Ø 5.0 | Body Ø 5.0

L	Art. No.
8	FXI 50 08
10	FXI 50 10
12	FXI 50 12
14	FXI 50 14

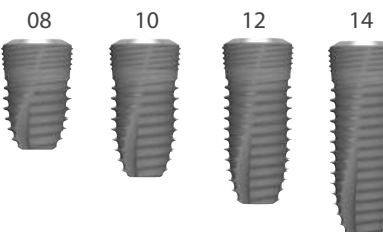

※ Note: To prevent damage to the Implant driver or fixture, do not over torque during fixture insertion

# Cover Screw

• Single use only

Unit: mm, Scale 1 : 1.5



CS36 and FXI4510P

Color: Green

Art. No.	CS36
----------	------





# Healing Abutment

• Single use only

Unit: mm, Scale 1 : 1.5



HAB453050L and FXI4510P

## Diameter Ø 3.3 / Ø 3.8

G/H	Art. No.
3.5	GBHAB 33 35
0.5	GBHAB 38 05
2.0	GBHAB 38 20

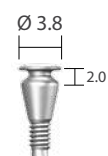

## Diameter Ø 4.0

G/H	H	Art. No.
2.0	2.0	HAB 40 20 20 L
2.0	3.5	HAB 40 20 35 L
3.0	5.0	HAB 40 30 50 L
4.0	7.0	HAB 40 40 70 L

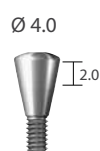

## Diameter Ø 4.5

G/H	H	Art. No.
2.0	2.0	HAB 45 20 20 L
2.0	3.5	HAB 45 20 35 L
3.0	5.0	HAB 45 30 50 L
4.0	7.0	HAB 45 40 70 L



※ Hex driver: Use no more than 5N-cm torque when screwing a cover screw to a fixture.  
If hex is worn, slot on the head of the product can be used to rotate it.

# Healing Abutment

• Single use only

Unit: mm, Scale 1 : 1.5

## Diameter Ø 5.5

G/H	H	Art. No.
2.0	2.0	HAB 55 20 20 L
2.0	3.5	HAB 55 20 35 L
3.0	5.0	HAB 55 30 50 L
4.0	7.0	HAB 55 40 70 L

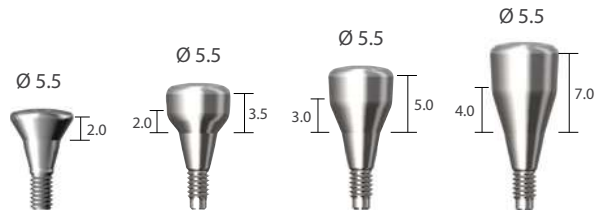

## Diameter Ø 6.5

G/H	H	Art. No.
2.0	2.0	HAB 65 20 20 L
2.0	3.5	HAB 65 20 35 L
3.0	5.0	HAB 65 30 50 L
4.0	7.0	HAB 65 40 70 L

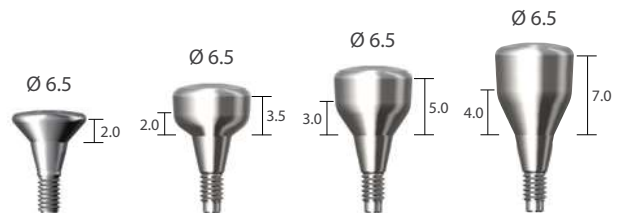

## Diameter Ø 7.5 / 8.5 / 9.5

G/H	H	Art. No.
3.0	5.0	HAB 75 30 50 L
3.0	5.0	HAB 85 30 50 L
3.0	5.0	HAB 95 30 50 L



※ Hex driver: Use no more than 5N-cm torque when screwing a cover screw to a fixture.  
If hex is worn, slot on the head of the product can be used to rotate it.

# Prosthetic Procedure 1

Impression Technique and Restoration Selection

## Dual / Combi Abutment

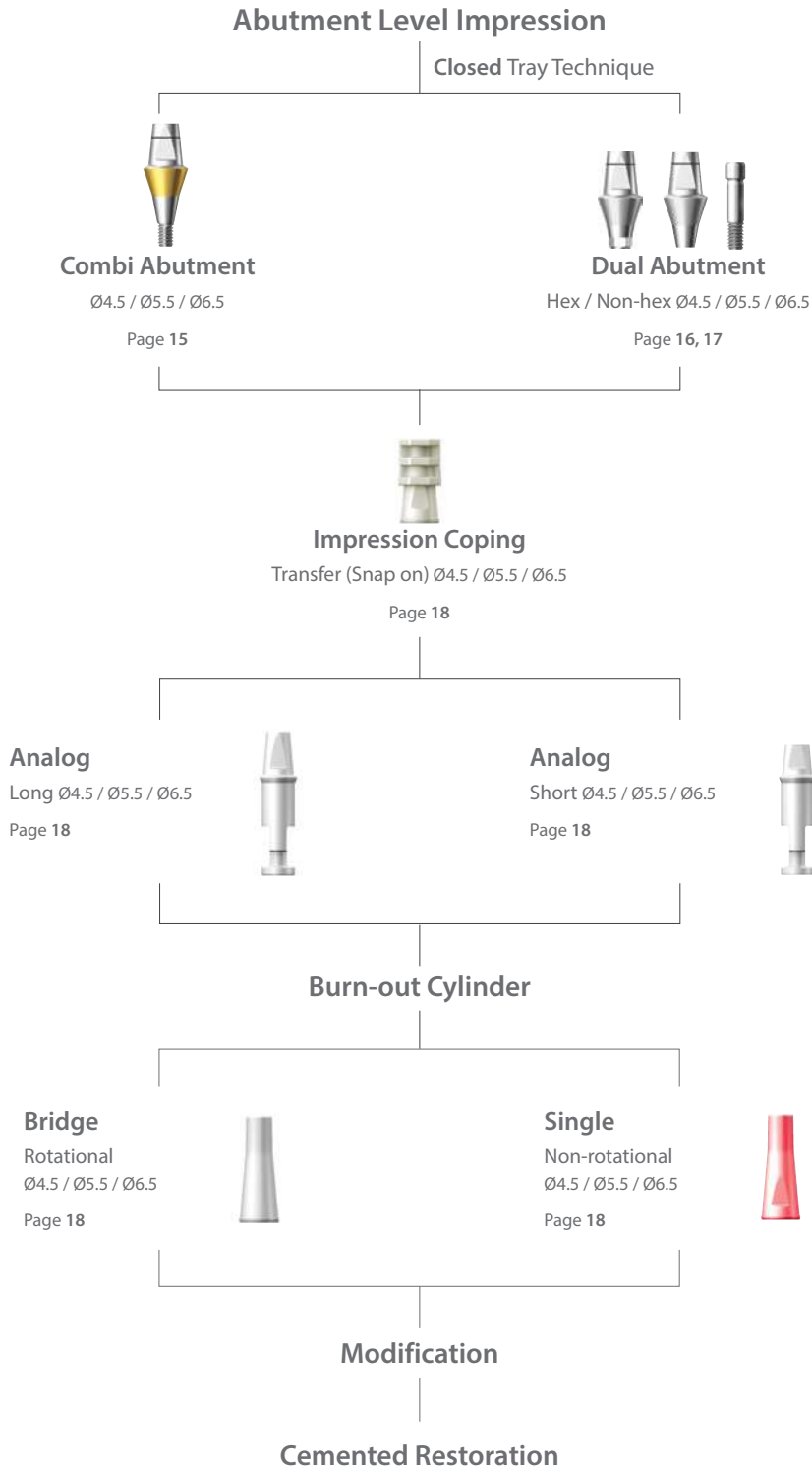



# Combi Abutment

Unit: mm, Scale 1 : 1



CAB5535SL and FXI4510P

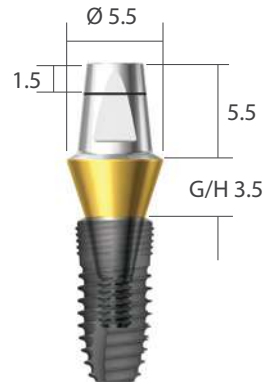

CAB5535L and FXI4510P

## Diameter Ø 4.5

G/H	Type	Art. No.	Type	Art. No
1.0	Short	CAB 45 10 SL	Long	CAB 45 10 L
1.5		CAB 45 15 SL		CAB 45 15 L
2.5		CAB 45 25 SL		CAB 45 25 L
3.5		CAB 45 35 SL		CAB 45 35 L
4.5		CAB 45 45 SL		CAB 45 45 L
5.5		CAB 45 55 SL		CAB 45 55 L

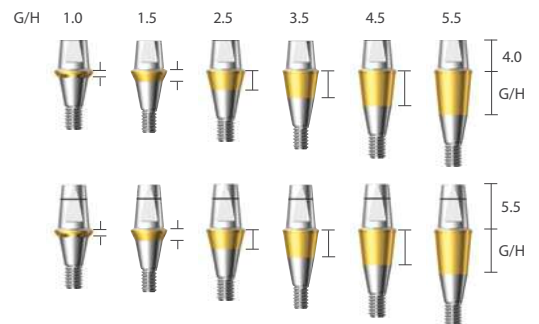

## Diameter Ø 5.5

G/H	Type	Art. No.	Type	Art. No
1.5	Short	CAB 55 15 SL	Long	CAB 55 15 L
2.5		CAB 55 25 SL		CAB 55 25 L
3.5		CAB 55 35 SL		CAB 55 35 L
4.5		CAB 55 45 SL		CAB 55 45 L
5.5		CAB 55 55 SL		CAB 55 55 L

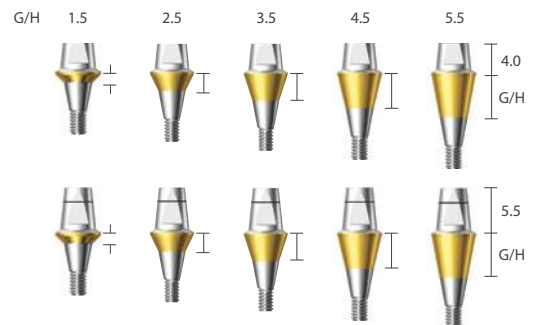

## Diameter Ø 6.5

G/H	Type	Art. No.	Type	Art. No
1.5	Short	CAB 65 15 SL	Long	CAB 65 15 L
2.5		CAB 65 25 SL		CAB 65 25 L
3.5		CAB 65 35 SL		CAB 65 35 L
4.5		CAB 65 45 SL		CAB 65 45 L
5.5		CAB 65 55 SL		CAB 65 55 L

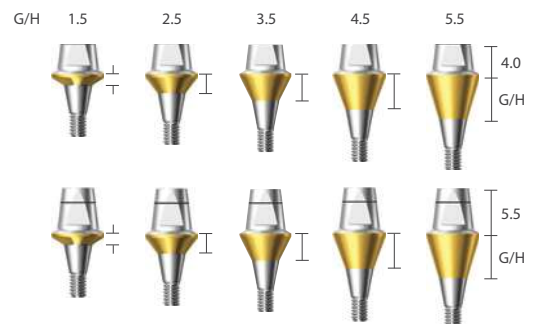

※ Note: It is recommended to keep the torque level at 25~30 N·cm to tighten the combi abutment with fixture

# Dual Abutment [Hex]

• Abutment screw is included

Unit: mm, Scale 1 : 1.5

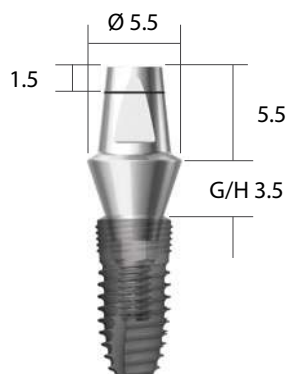

DAB5535HT and FXI4510P

## Diameter Ø 4.5 | Hex

G/H	Art. No.
1.0	DAB 45 10 HT
1.5	DAB 45 15 HT
2.5	DAB 45 25 HT
3.5	DAB 45 35 HT
4.5	DAB 45 45 HT
5.5	DAB 45 55 HT

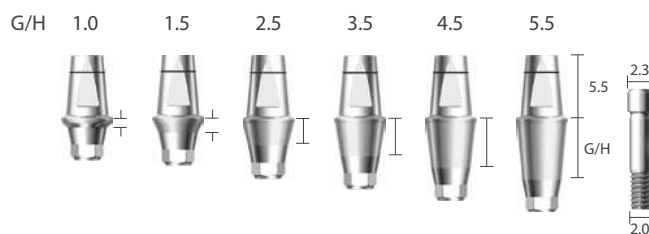

## Diameter Ø 5.5 | Hex

G/H	Art. No.
1.5	DAB 55 15 HT
2.5	DAB 55 25 HT
3.5	DAB 55 35 HT
4.5	DAB 55 45 HT
5.5	DAB 55 55 HT

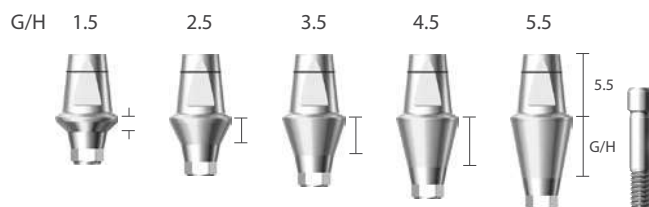

## Diameter Ø 6.5 | Hex

G/H	Art. No.
1.5	DAB 65 15 HT
2.5	DAB 65 25 HT
3.5	DAB 65 35 HT
4.5	DAB 65 45 HT
5.5	DAB 65 55 HT

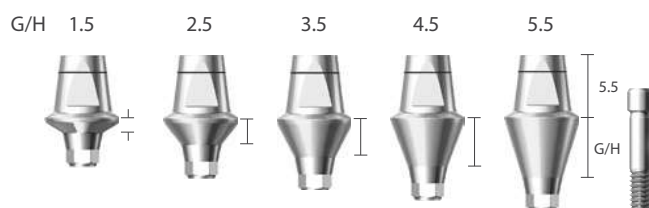

※ Note: It is recommended to keep the torque level at 25~30 N·cm to tighten the dual abutment with fixture

# Dual Abutment [Non-hex]

• Abutment screw is included

Unit: mm, Scale 1 : 1.5

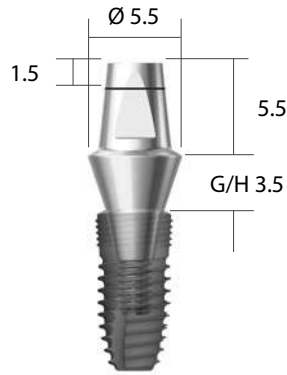

DAB5535NT and FXI4510P

## Diameter Ø 4.5 | Non-hex

G/H	Art. No.
1.0	DAB 45 10 NT
1.5	DAB 45 15 NT
2.5	DAB 45 25 NT
3.5	DAB 45 35 NT
4.5	DAB 45 45 NT
5.5	DAB 45 55 NT

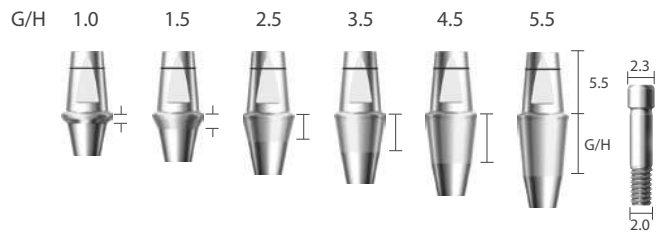

## Diameter Ø 5.5 | Non-hex

G/H	Art. No.
1.5	DAB 55 15 NT
2.5	DAB 55 25 NT
3.5	DAB 55 35 NT
4.5	DAB 55 45 NT
5.5	DAB 55 55 NT

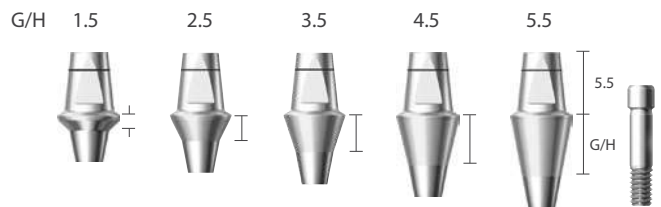

## Diameter Ø 6.5 | Non-hex

G/H	Art. No.
1.5	DAB 65 15 NT
2.5	DAB 65 25 NT
3.5	DAB 65 35 NT
4.5	DAB 65 45 NT
5.5	DAB 65 55 NT

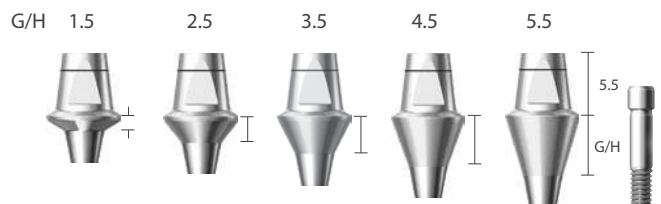

※ Note: It is recommended to keep the torque level at 25~30 N·cm to tighten the dual abutment with fixture



# Abutment Level Impression Components

Unit: mm, Scale 1 : 1.5

## Comfort Cap | Snap on

Type	Diameter	Art. No.
Short	Ø 4.5	CCC 45 CS
	Ø 5.5	CCC 55 CS
	Ø 6.5	CCC 65 CS
Long	Ø 4.5	CCC 45 C
	Ø 5.5	CCC 55 C
	Ø 6.5	CCC 65 C



## Impression Coping

Diameter	Art. No.
Ø 4.5	CIC 45 L
Ø 5.5	CIC 55 L
Ø 6.5	CIC 65 L



## Lab Analog

Type	Diameter	Art. No.
Short	Ø 4.5	CAN 45 SL
	Ø 5.5	CAN 55 SL
	Ø 6.5	CAN 65 SL
Long	Ø 4.5	CAN 45 LL
	Ø 5.5	CAN 55 LL
	Ø 6.5	CAN 65 LL

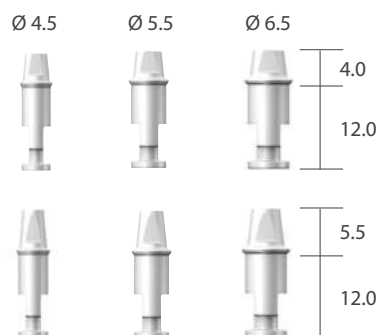

## Burn-out Cylinder

Type	Diameter	Art. No.
Single	Ø 4.5	CBC 45 SL
	Ø 5.5	CBC 55 SL
	Ø 6.5	CBC 65 SL
Bridge	Ø 4.5	CBC 45 BL
	Ø 5.5	CBC 55 BL
	Ø 6.5	CBC 65 BL

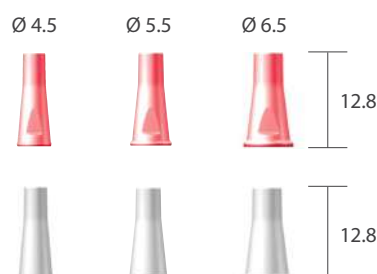

# Restorative Kit



## Combi & Dual Abutment

Art. No	Lab. Components				
	Comfort Cap	Impression Coping	Analog	Burn-out Cylinder	
XSDAB 45 S	CCC 45 CS	CIC 45 L	CAN 45 SL	CBC 45 SL	CBC 45 BL
XSDAB 45	CCC 45 C		CAN 45 LL		
XSDAB 55 S	CCC 55 CS	CIC 55 L	CAN 55 SL	CBC 55 SL	CBC 55 BL
XSDAB 55	CCC 55 C		CAN 55 LL		
XSDAB 65 S	CCC 65 CS	CIC 65 L	CAN 65 SL	CBC 65 SL	CBC 65 BL
XSDAB 65	CCC 65 C		CAN 65 LL		

# Prosthetic Procedure 2

Impression Technique and Restoration Selection

Dual / Custom / Dual Milling / Angled / Direct-Casting /  
Metal-Casting / Temporary (Plastic & Ti) Abutment

## Fixture Level Impression



### Analog

DANSE  
Page 21, 22



### Dual Abutment

Hex / Non-hex  
Ø4.5 / Ø5.5 / Ø6.5

Page 16, 17



### Custom Abutment

Hex / Non-hex  
Ø4.5 / Ø5.5

Page 23



### Dual Milling Abutment

Hex / Non-hex  
Ø4.0 / Ø4.5  
Ø5.5 / Ø6.5 / Ø7.5

Page 24, 25



### Angled Abutment

Hex / Non-hex  
15° / 25°  
Ø4.5 / Ø5.5

Page 26, 27

Modification

Cemented  
Restoration



### Direct-Casting Abutment

Hex / Non-hex  
Ø4.5

Page 28



### Metal-Casting Abutment

Hex / Non-hex  
Ø4.5

Page 28



### Temporary Abutment

Hex / Non-hex  
Ø4.5 / Ø5.5 / Ø6.5

Page 29

Modification

Screw-Retained  
Restoration

# Fixture Level Impression Components

• Impression coping screw is included with Impression coping

Unit: mm, Scale 1 : 1.5

## Impression Coping Pick-up Ø 4.0

Size	Type	Art. No.
Short	<b>Hex</b>	DPU 40 11 HL
Short	<b>Non-hex</b>	DPU 40 11 NL
Long	<b>Hex</b>	DPU 40 15 HL
Long	<b>Non-hex</b>	DPU 40 15 NL

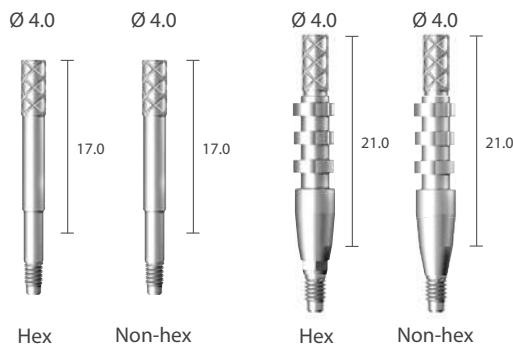

## Impression Coping Pick-up Ø 4.5

Size	Type	Art. No.
Short	<b>Hex</b>	DPU 45 11 HL
Short	<b>Non-hex</b>	DPU 45 11 NL
Long	<b>Hex</b>	DPU 45 15 HL
Long	<b>Non-hex</b>	DPU 45 15 NL

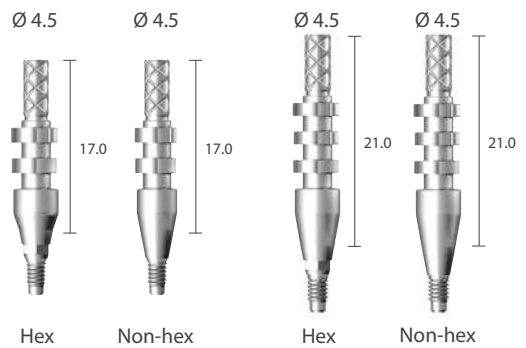

## Impression Coping Pick-up Ø 5.5

Size	Type	Art. No.
Short	<b>Hex</b>	DPU 55 11 HL
Short	<b>Non-hex</b>	DPU 55 11 NL
Long	<b>Hex</b>	DPU 55 15 HL
Long	<b>Non-hex</b>	DPU 55 15 NL

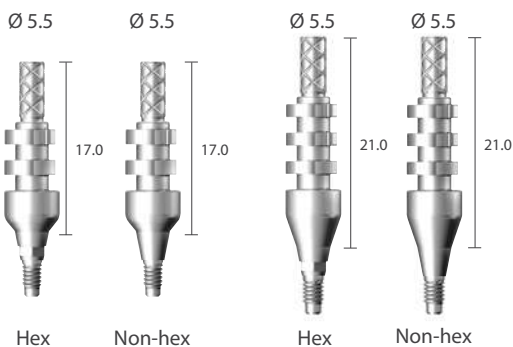

## Impression Coping Pick-up Ø 6.5

Size	Type	Art. No.
Short	<b>Hex</b>	DPU 65 11 HL
Short	<b>Non-hex</b>	DPU 65 11 NL
Long	<b>Hex</b>	DPU 65 15 HL
Long	<b>Non-hex</b>	DPU 65 15 NL

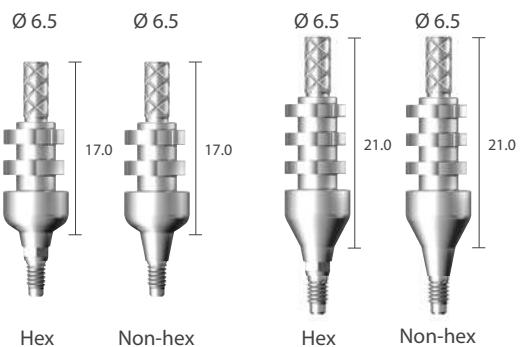

## Impression Coping Pick-up Screw

Size	Art. No.
Short	DPS 11
Long	DPS 15

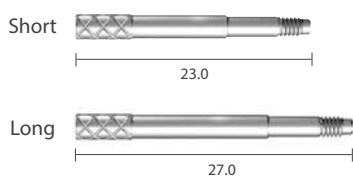

## Analogue

Application (BodyØ)	Art. No.
Ø 3.6 / Ø 4.0 / Ø 4.5 / Ø 5.0	DANSE



# Fixture Level Impression Components

• Impression coping screw is included with Impression coping

Unit: mm, Scale 1 : 1.5

## Impression Coping Transfer Ø 4.0

Size	Type	Art. No.
Short	Hex	DTF 40 11 HL
Short	Non-hex	DTF 40 11 NL
Long	Hex	DTF 40 15 HL
Long	Non-hex	DTF 40 15 NL

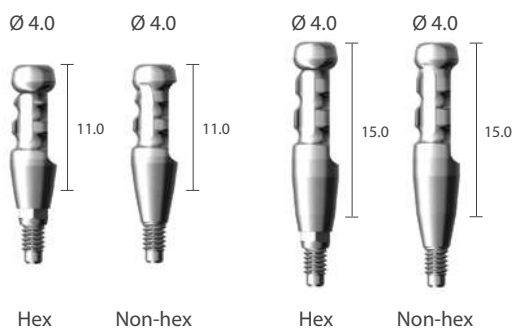

## Impression Coping Transfer Ø 4.5

Size	Type	Art. No.
Short	Hex	DTF 45 11 HL
Short	Non-hex	DTF 45 11 NL
Long	Hex	DTF 45 15 HL
Long	Non-hex	DTF 45 15 NL

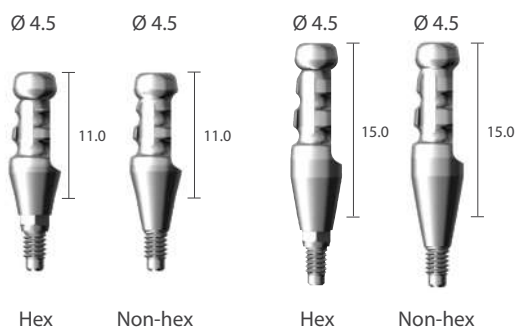

## Impression Coping Transfer Ø 5.5

Size	Type	Art. No.
Short	Hex	DTF 55 11 HL
Short	Non-hex	DTF 55 11 NL
Long	Hex	DTF 55 15 HL
Long	Non-hex	DTF 55 15 NL

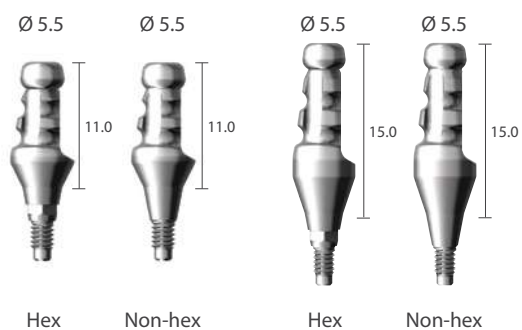

## Impression Coping Transfer Ø 6.5

Size	Type	Art. No.
Short	Hex	DTF 65 11 HL
Short	Non-hex	DTF 65 11 NL
Long	Hex	DTF 65 15 HL
Long	Non-hex	DTF 65 15 NL

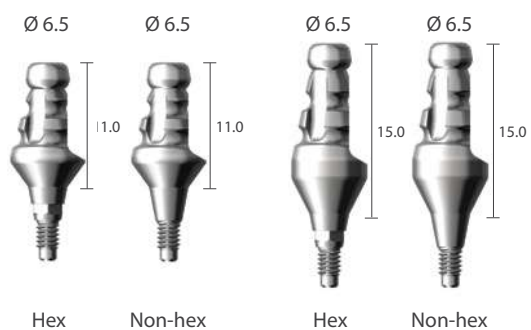

## Impression Coping Transfer Screw

Size	Art. No.
Short	DTS 11
Long	DTS 15

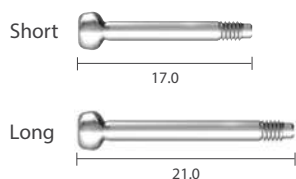

## Analog

Application (Body Ø)	Art. No.
Ø 3.6 / Ø 4.0 / Ø 4.5 / Ø 5.0	DANSE





# Custom Abutment

• Abutment screw is included

Unit: mm, Scale 1 : 1.5

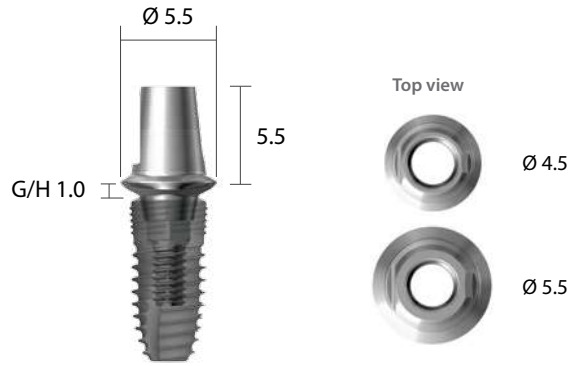

CDAB5510HT and FXI5510P

## Diameter Ø 4.5

G/H	Type	Art. No.
0.5	Hex	CDAB 45 05 HT
0.5	Non-hex	CDAB 45 05 NT
1.5	Hex	CDAB 45 15 HT
1.5	Non-hex	CDAB 45 15 NT

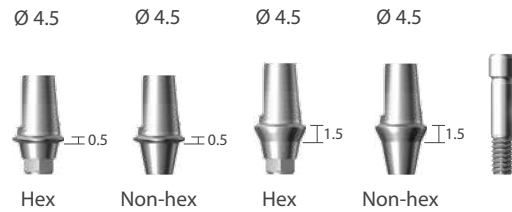

## Diameter Ø 5.5

G/H	Type	Art. No.
1.0	Hex	CDAB 55 10 HT
1.0	Non-hex	CDAB 55 10 NT
2.0	Hex	CDAB 55 20 HT
2.0	Non-hex	CDAB 55 20 NT



※ Note: It is recommended to keep the torque level at 25~30 N·cm to tighten the custom abutment with fixture

# Dual Milling Abutment

• Abutment screw is included

Unit: mm, Scale 1 : 1.5

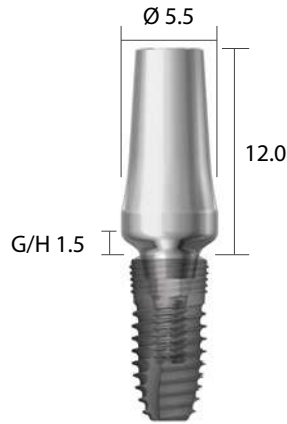

DAB55157HT and FXI4510P

## Diameter Ø 4.0

G/H	Type	Art. No.
1.0	Hex	DAB 40 105 HT
1.0	Non-hex	DAB 40 105 NT

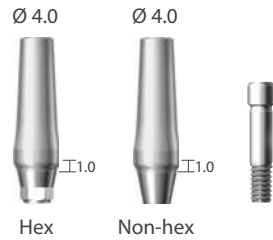

## Diameter Ø 4.5

G/H	Type	Art. No.
1.5	Hex	DAB 45 156 HT
1.5	Non-hex	DAB 45 156 NT

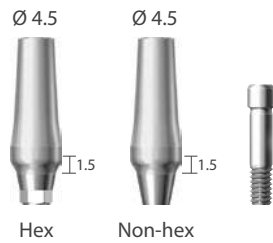

## Diameter Ø 5.5

G/H	Type	Art. No.
1.5	Hex	DAB 55 157 HT
1.5	Non-hex	DAB 55 157 NT
2.5	Hex	DAB 55 257 HT
2.5	Non-hex	DAB 55 257 NT



※ Note: It is recommended to keep the torque level at 25~30 N·cm to tighten the dual milling abutment with fixture

# Dual Milling Abutment

• Abutment screw is included

Unit: mm, Scale 1 : 1.5

## Diameter Ø 6.5

G/H	Type	Art. No.
1.5	Hex	DAB 65 158 HT
1.5	Non-hex	DAB 65 158 NT
2.5	Hex	DAB 65 258 HT
2.5	Non-hex	DAB 65 258 NT
3.5	Hex	DAB 65 358 HT
3.5	Non-hex	DAB 65 358 NT

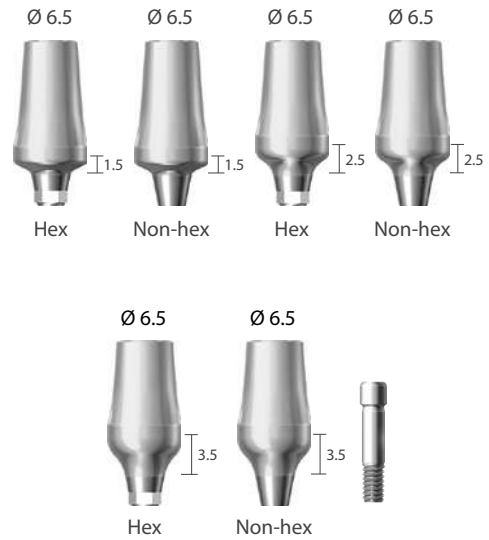

## Diameter Ø 7.5

G/H	Type	Art. No.
2.5	Hex	DAB 75 259 HT
2.5	Non-hex	DAB 75 259 NT
3.5	Hex	DAB 75 359 HT
3.5	Non-hex	DAB 75 359 NT



※ Note: It is recommended to keep the torque level at 25~30 N·cm to tighten the dual milling abutment with fixture

# Angled Abutment [15°]

• Abutment screw is included

Unit: mm, Scale 1 : 1.5

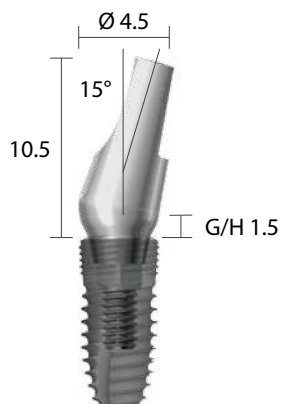

AAB154515HT and FXI4510P

## Diameter Ø 4.5 | Angled 15°

G/H	Type	Art. No.
1.5	Hex	AAB 15 45 15 HT
1.5	Non-hex	AAB 15 45 15 NT
2.5	Hex	AAB 15 45 25 HT
2.5	Non-hex	AAB 15 45 25 NT
3.5	Hex	AAB 15 45 35 HT
3.5	Non-hex	AAB 15 45 35 NT

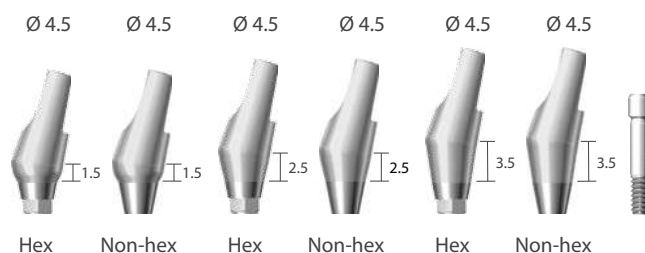

## Diameter Ø 5.5 | Angled 15°

G/H	Type	Art. No.
1.5	Hex	AAB 15 55 15 HT
1.5	Non-hex	AAB 15 55 15 NT
2.5	Hex	AAB 15 55 25 HT
2.5	Non-hex	AAB 15 55 25 NT
3.5	Hex	AAB 15 55 35 HT
3.5	Non-hex	AAB 15 55 35 NT

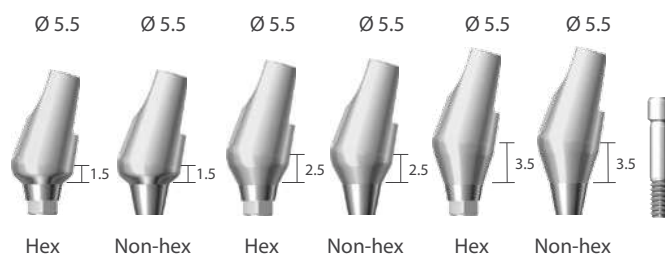

※ Note: It is recommended to keep the torque level at 25~30 N·cm to tighten the angled abutment with fixture

# Angled Abutment [25°]

• Abutment screw is included

Unit: mm, Scale 1 : 1.5

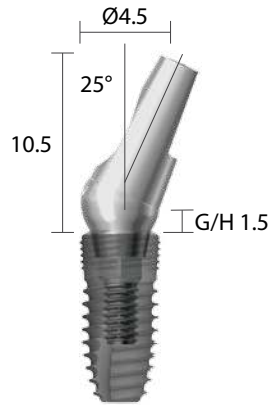

AAB254515HT and FXI4510P

## Diameter Ø 4.5 | Angled 25°

G/H	Type	Art. No.
1.5	Hex	AAB 25 45 15 HT
1.5	Non-hex	AAB 25 45 15 NT
2.5	Hex	AAB 25 45 25 HT
2.5	Non-hex	AAB 25 45 25 NT
3.5	Hex	AAB 25 45 35 HT
3.5	Non-hex	AAB 25 45 35 NT

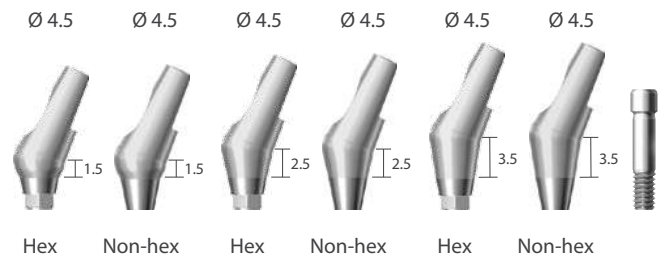

## Diameter Ø 5.5 | Angled 25°

G/H	Type	Art. No.
1.5	Hex	AAB 25 55 15 HT
1.5	Non-hex	AAB 25 55 15 NT
2.5	Hex	AAB 25 55 25 HT
2.5	Non-hex	AAB 25 55 25 NT
3.5	Hex	AAB 25 55 35 HT
3.5	Non-hex	AAB 25 55 35 NT

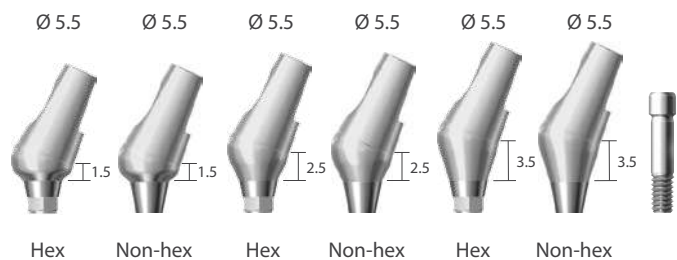

※ Note: It is recommended to keep the torque level at 25~30 N·cm to tighten the angled abutment with fixture



# Direct-Casting Abutment / Metal-Casting Abutment

• Abutment screw is included

Unit: mm, Scale 1 : 1.5



RAB45GHT and FXI4510P

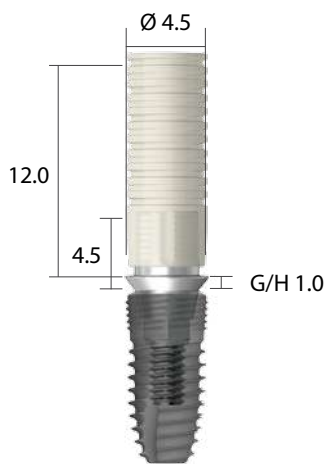

RAB45CHT and FXI4510P

## Direct-Casting Abutment | Gold

G/H	Type	Art. No.
1.0	Hex	RAB 45 GHT
1.0	Non-hex	RAB 45 GNT

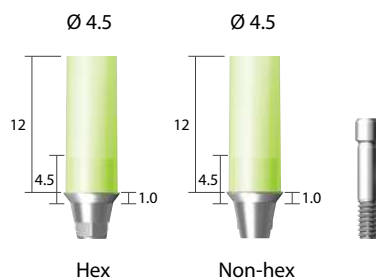

## Metal-Casting Abutment | Co-Cr

G/H	Type	Art. No.
1.0	Hex	RAB 45 CHT
1.0	Non-hex	RAB 45 CNT

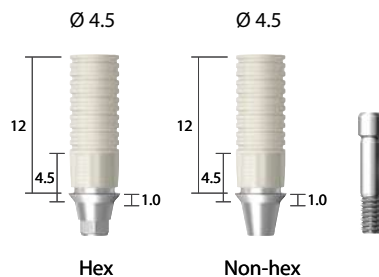

※ Note: It is recommended to keep the torque level at 25~30 N·cm to tighten the direct casting/metal casting abutment with fixture

# Temporary Abutment

• Abutment screw is included

Unit: mm, Scale 1 : 1.5

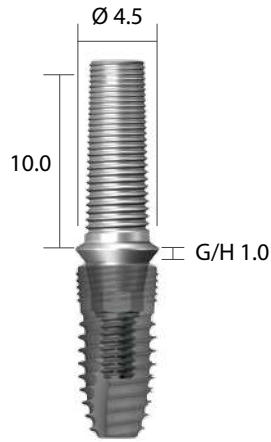

RAB45HTG and FXI4510P

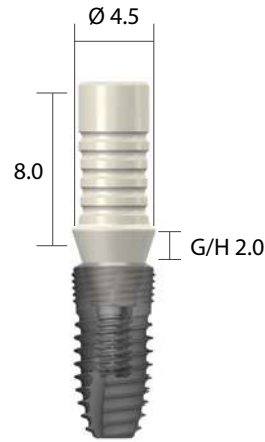

RAB4520PHL and FXI4510P

## Ti-Temporary Abutment

Diameter	G/H	Type	Art. No.
Ø4.5	1.0	Hex	RAB 45 HTG
Ø4.5	1.0	Non-hex	RAB 45 NTG

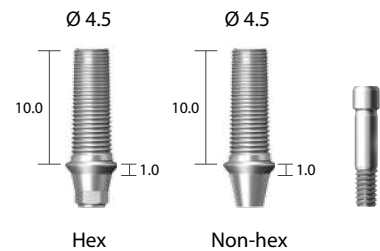

## Plastic Temporary Abutment

Diameter	G/H	Type	Art. No.
Ø4.5	2.0	hex	RAB 45 20 PHL
Ø4.5	2.0	Non-hex	RAB 45 20 PNL
Ø5.5	2.0	hex	RAB 55 20 PHL
Ø5.5	2.0	Non-hex	RAB 55 20 PNL
Ø6.5	2.0	hex	RAB 65 20 PHL
Ø6.5	2.0	Non-hex	RAB 65 20 PNL

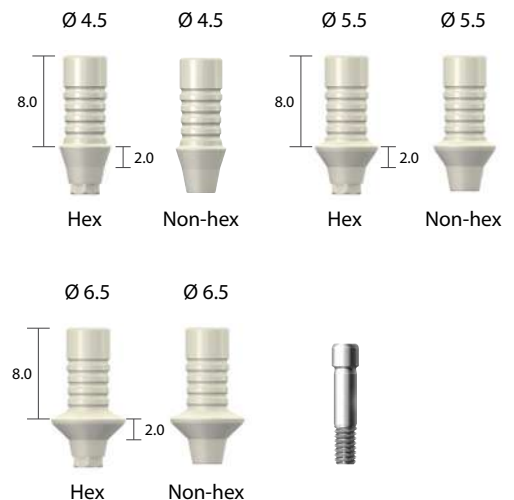

※ Note: It is recommended to keep the torque level at 25~30 N·cm to tighten the temporary abutment with fixture

# Prosthetic Procedure 3

Impression Technique and Restoration Selection

## Screw Abutment

### Abutment Level Impression

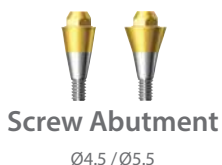

Page 31



Page 32

Open Tray Technique



Page 33

Closed Tray Technique



Page 33

### Analog

Ø4.5 / Ø5.5

Page 34



### Burn-out Cylinder

Ø4.5 / Ø5.5

Page 35



### Gold Cylinder

Ø4.5 / Ø5.5

Page 35



### Metal Cylinder

Ø4.5 / Ø5.5

Page 35



### Titanium Cylinder

Ø4.5 / Ø5.5

Page 34



Bridge (Non-hex)    Single (Hex)

Bridge (Non-hex)    Single (Hex)

Bridge (Non-hex)    Single (Hex)

Bridge (Non-hex)    Single (Hex)

### Polishing Protector

Ø4.5 / Ø5.5

Page 34



### Temporary Restoration



### Screw-Retained Restoration

# Screw Abutment

Unit: mm, Scale 1 : 1.5



Delivery Holder

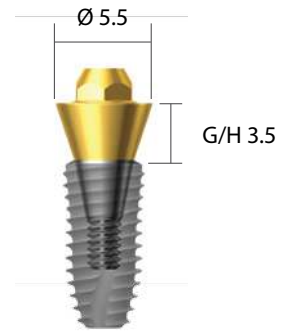

SAB5535L and FXI4510P

## Diameter Ø 4.5

G/H	Art. No.
1.0	SAB45 10 L
1.5	SAB45 15 L
2.5	SAB45 25 L
3.5	SAB45 35 L
4.5	SAB45 45 L
5.5	SAB45 55 L

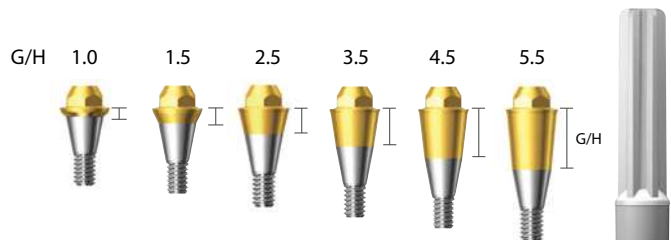

## Diameter Ø 5.5

G/H	Art. No.
1.5	SAB55 15 L
2.5	SAB55 25 L
3.5	SAB55 35 L
4.5	SAB55 45 L
5.5	SAB55 55 L

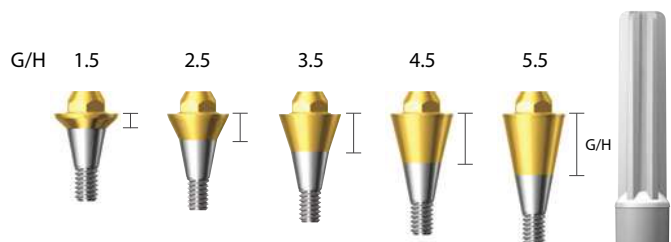

※ Note: It is recommended to keep the torque level at 25~30 N·cm to tighten the screw abutment with fixture

# Angled Screw Abutment

Unit: mm, Scale 1 : 1.5

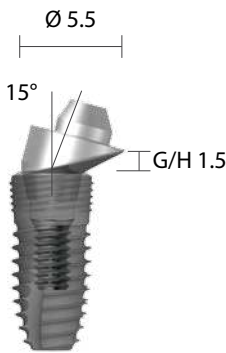

ASA55151518HTand FXI4510P

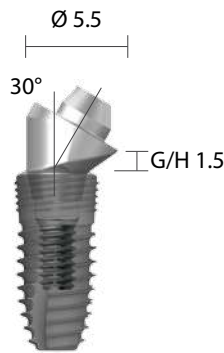

ASA55301518HTand FXI4510P



Delivery Holder

## Angled Screw Abutment Ø 4.5

G/H	Type	Art. No.
1.0	Hex	ASA 45 15 10 18 HT
1.0	Non-hex	ASA 45 15 10 18 NT
1.0	Hex	ASA 45 30 10 18 HT
1.0	Non-hex	ASA 45 30 10 18 NT
2.0	Hex	ASA 45 15 20 18 HT
2.0	Non-hex	ASA 45 15 20 18 NT
2.0	Hex	ASA 45 30 20 18 HT
2.0	Non-hex	ASA 45 30 20 18 NT

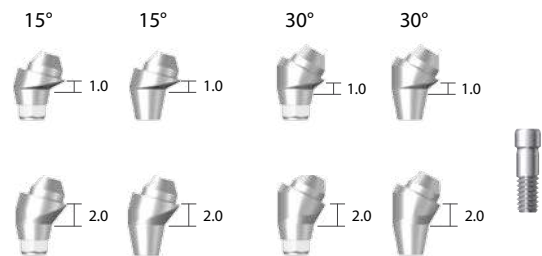

## Angled Screw Abutment Ø 5.5

G/H	Type	Art. No.
1.5	Hex	ASA 55 15 15 18 HT
1.5	Non-hex	ASA 55 15 15 18 NT
1.5	Hex	ASA 55 30 15 18 HT
1.5	Non-hex	ASA 55 30 15 18 NT
3.0	Hex	ASA 55 15 30 18 HT
3.0	Non-hex	ASA 55 15 30 18 NT
3.0	Hex	ASA 55 30 30 18 HT
3.0	Non-hex	ASA 55 30 30 18 NT

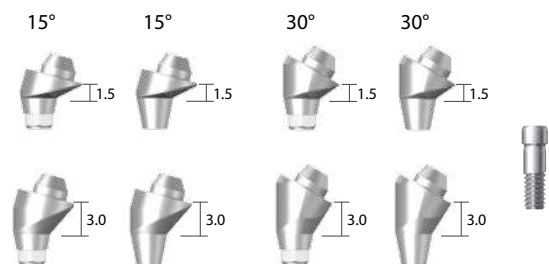

## Angled Screw Abutment Screw

ASASC 20 23

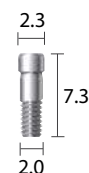

※ Note: It is recommended to keep the torque level at 25~30 N·cm to tighten the angled screw abutment with fixture



# Screw Abutment Impression Components

Unit: mm, Scale 1 : 1.5

## Impression Coping Pick-up

Diameter	Type		Art. No.
Ø4.5	Single	Hex	SPU 45 SL
Ø4.5	Bridge	Non-hex	SPU 45 BL
Ø5.5	Single	Hex	SPU 55 SL
Ø5.5	Bridge	Non-hex	SPU 55 BL

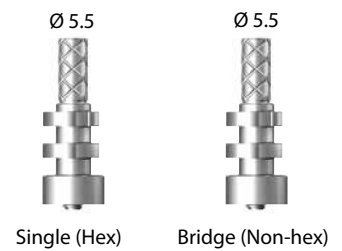
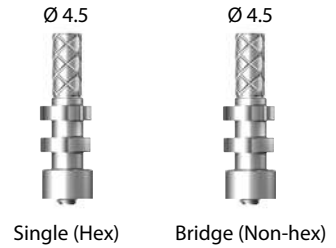

## Impression Coping Transfer

Diameter	Type		Art. No.
Ø4.5	Single	Hex	STF 45 SL
Ø4.5	Bridge	Non-hex	STF 45 BL
Ø5.5	Single	Hex	STF 55 SL
Ø5.5	Bridge	Non-hex	STF 55 BL

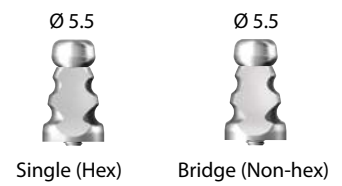
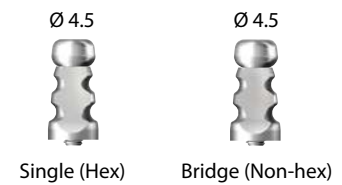

## Impression Coping Screw

Type	Art. No.
Pick-up	SPS 09
Transfer	STS 09

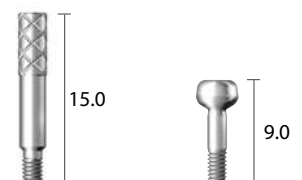

# Screw Abutment Impression Components

Unit: mm, Scale 1 : 1.5

## Comfort Cap

Diameter	Art. No.
Ø4.5	SCC 45 L
Ø5.5	SCC 55 L

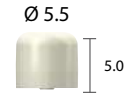
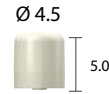

## Analog

Diameter	Art. No.
Ø4.5	SAN 45 L
Ø5.5	SAN 55 L

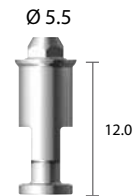
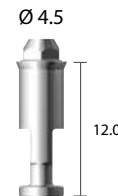

## Polishing Protector

Diameter	Art. No.
Ø4.5	SPP 45 L
Ø5.5	SPP 55 L



## Ti-Retaining Screw

SRS 18 T
----------



## Ti-Cylinder

Diameter	Type		Art. No.
Ø4.5	Single	Hex	STC 45 SG
Ø4.5	Bridge	Non-hex	STC 45 BG
Ø5.5	Single	Hex	STC 55 SG
Ø5.5	Bridge	Non-hex	STC 55 BG

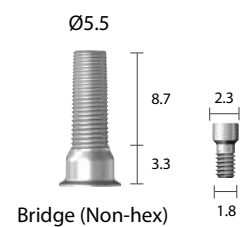
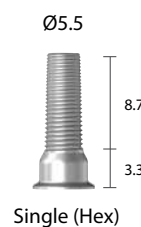
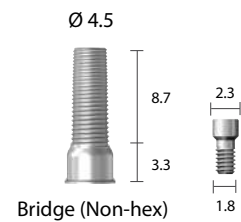
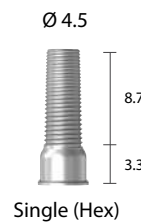

# Screw Abutment Impression Components

Unit: mm, Scale 1 : 1.5

## Gold Cylinder

Diameter	Type		Art. No.
Ø4.5	Single	Hex	SGC 45 SL
Ø4.5	Bridge	Non-hex	SGC 45 BL
Ø5.5	Single	Hex	SGC 55 SL
Ø5.5	Bridge	Non-hex	SGC 55 BL

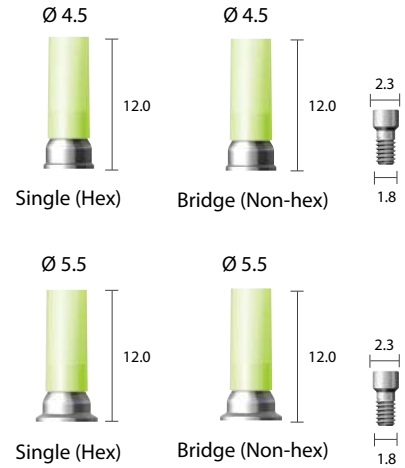

## Metal Cylinder | Co-Cr

Diameter	Type		Art. No.
Ø4.5	Single	Hex	SGC 45 CSL
Ø4.5	Bridge	Non-hex	SGC 45 CBL
Ø5.5	Single	Hex	SGC 55 CSL
Ø5.5	Bridge	Non-hex	SGC 55 CBL

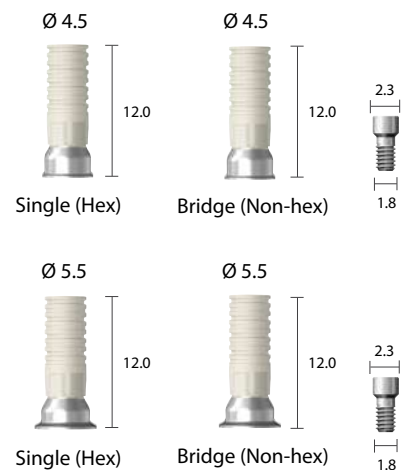

## Burn-out Cylinder

Diameter	Type		Art. No.
Ø4.5	Single	Hex	SBC 45 SL
Ø4.5	Bridge	Non-hex	SBC 45 BL
Ø5.5	Single	Hex	SBC 55 SL
Ø5.5	Bridge	Non-hex	SBC 55 BL

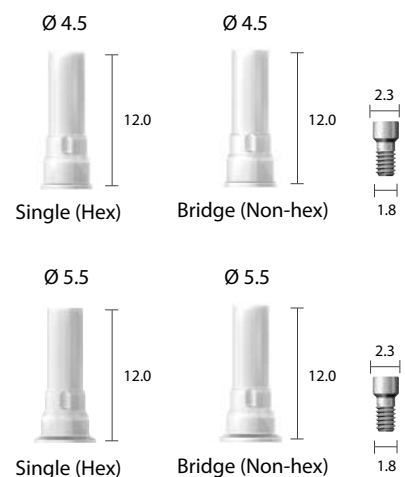

# Prosthetic Procedure 4

Impression Technique and Restoration Type

## Overdenture Procedure

### Positioner / Mini Ball / Magnetic Attachment



**Positioner Abutment**

Ø3.5

Page 37



**Mini Ball Abutment**

Ø3.5

Page 39



**Implant Keeper**

Ø4.5 / Ø5.5

Page 40



**Implant Keeper**

Ø4.5 / Ø5.5

Page 41

#### Abutment Level Impression



**Positioner Impression Coping**

Page 37



**Mini Ball Impression Coping**

Page 39



**Positioner Analog**

Page 37



**Mini Ball Analog**

Page 39



**Block Out Spacer**

Page 38



**Socket Spacer**

Page 39



**Positioner Metal Socket / Plastic Socket**

Page 38



**Mini Denture Socket and O-ring**

Page 39



**Magnetic Assay**

Page 40



**Magnetic Assay**

Page 40

**Positioner Attachment for Overdenture**

**Mini Ball and Socket Attachment for Overdenture**

**Magnetic Attachment for Overdenture**

# Positioner

Unit: mm, Scale 1 : 1.5

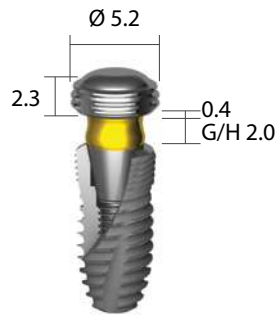

FSMH and PAB3520 and FXI4510P

## Positioner Abutment

G/H	Art. No.
1.0	PAB 35 10
2.0	PAB 35 20
3.0	PAB 35 30
4.0	PAB 35 40
5.0	PAB 35 50
6.0	PAB 35 60
7.0	PAB 35 70

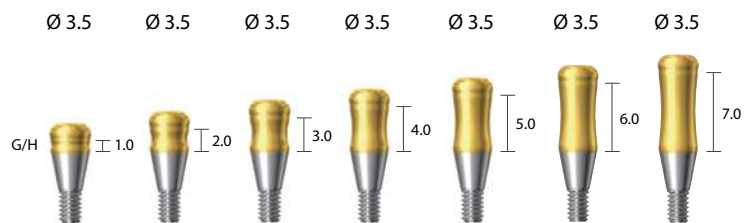

## Positioner Impression Coping

PIC
-----



## Positioner Analog

PAN
-----



※ Note: It is recommended to keep the torque level at 25~30 N·cm to tighten the positioner abutment with fixture

# Positioner

Unit: mm, Scale 1 : 1.5

## Positioner Socket Set

Art. No.	FSMHS (Tilting Type $\pm 10^\circ$ )
	FSMHSN (Non Tilting Type $\pm 5^\circ$ )



## Positioner Metal Socket

Art. No.	FSMH
----------	------



## Positioner Plastic Socket

Application	Art. No.
Tilting Type $\pm 10^\circ$	MSHP (Blue)
	MSMP (Orange)
	MSLP (Ivory)
	MSOP (White)
Non Tilting Type $\pm 5^\circ$	MSHPN (Blue)
	MSMPN (Orange)
	MSLPN (Ivory)
	MSOP (White)

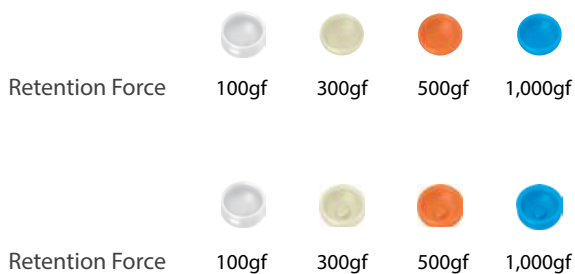

## Positioner Block Out Spacer

Art. No.	PBOS
----------	------



## Positioner Core Tool

Art. No.	XPCT
----------	------



# Mini Ball Attachment

Unit: mm, Scale 1 : 1.5

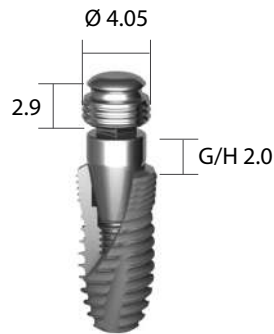

BPF3 and BAB352018 and FXI4510P

## Mini Ball Abutment

G/H	Art. No.
0	BAB 35 0018
1.0	BAB 35 1018
2.0	BAB 35 2018
3.0	BAB 35 3018
4.0	BAB 35 4018
5.0	BAB 35 5018

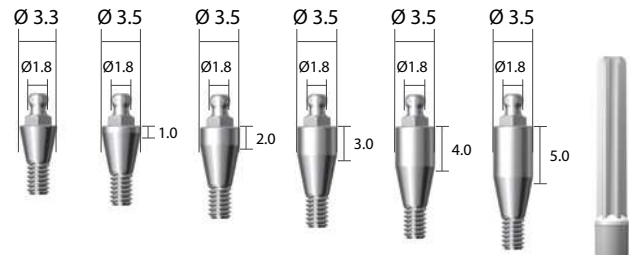

## Mini Ball Impression Coping

GICA
------

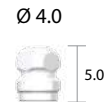

## Mini Ball Analog

BANL
------



## Socket Spacer

Art. No.	GBIC3L GBIC2L
----------	------------------



## Female Socket

Art. No.	BPF3 (300~500gf) BPF2 (500~700gf)
----------	--------------------------------------

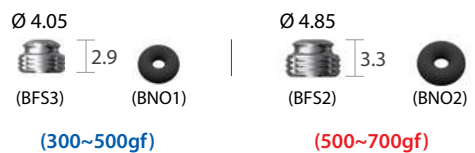

※ Note: It is recommended to keep the torque level at 25~30 N·cm to tighten the mini ball abutment with fixture



# Magnetic Attachment [Dome Type]

Unit: mm, Scale 1 : 1.5

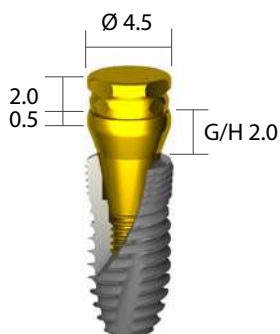

MGT4520D and MKP4520D and FXI4510P

## Magnetic Assay

Application	Diameter	H	Art. No.
MKP45D	Ø4.5	2.0	MGT 45 20 D
MKP55D	Ø5.5	2.0	MGT 55 20 D

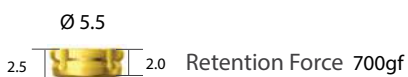
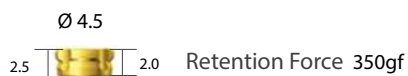

## Implant Keeper Diameter Ø 4.5

G/H	Art. No.
1.0	MKP 45 10 D
2.0	MKP 45 20 D
3.0	MKP 45 30 D
4.0	MKP 45 40 D
5.0	MKP 45 50 D
6.0	MKP 45 60 D

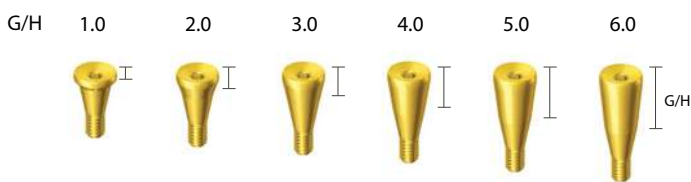

## Implant Keeper Diameter Ø 5.5

G/H	Art. No.
1.0	MKP 55 10 D
2.0	MKP 55 20 D
3.0	MKP 55 30 D
4.0	MKP 55 40 D
5.0	MKP 55 50 D
6.0	MKP 55 60 D

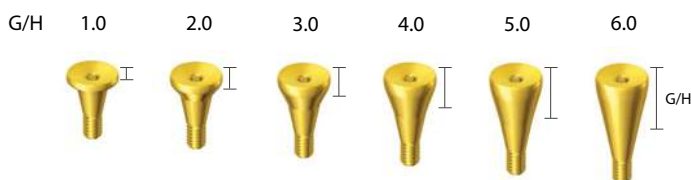

※ Note: It is recommended to keep the torque level at 25~30 N·cm to tighten the magnetic abutment with fixture

# Magnetic Attachment [Flat Type]

Unit: mm, Scale 1 : 1.5

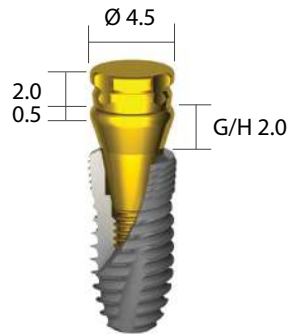

MGT4515 and MKP4520 and FXI4510P

## Magnetic Assay

Application	Diameter	H	Art. No.
MKP45	Ø4.5	1.5	MGT 45 15
MKP45	Ø4.5	2.0	MGT 45 20
MKP55	Ø5.5	1.5	MGT 55 15
MKP55	Ø5.5	2.0	MGT 55 20



## Implant Keeper Diameter Ø 4.5

G/H	Art. No.
1.0	MKP 45 10
2.0	MKP 45 20
3.0	MKP 45 30
4.0	MKP 45 40
5.0	MKP 45 50
6.0	MKP 45 60



## Implant Keeper Diameter Ø 5.5

G/H	Art. No.
1.0	MKP 55 10
2.0	MKP 55 20
3.0	MKP 55 30
4.0	MKP 55 40
5.0	MKP 55 50
6.0	MKP 55 60







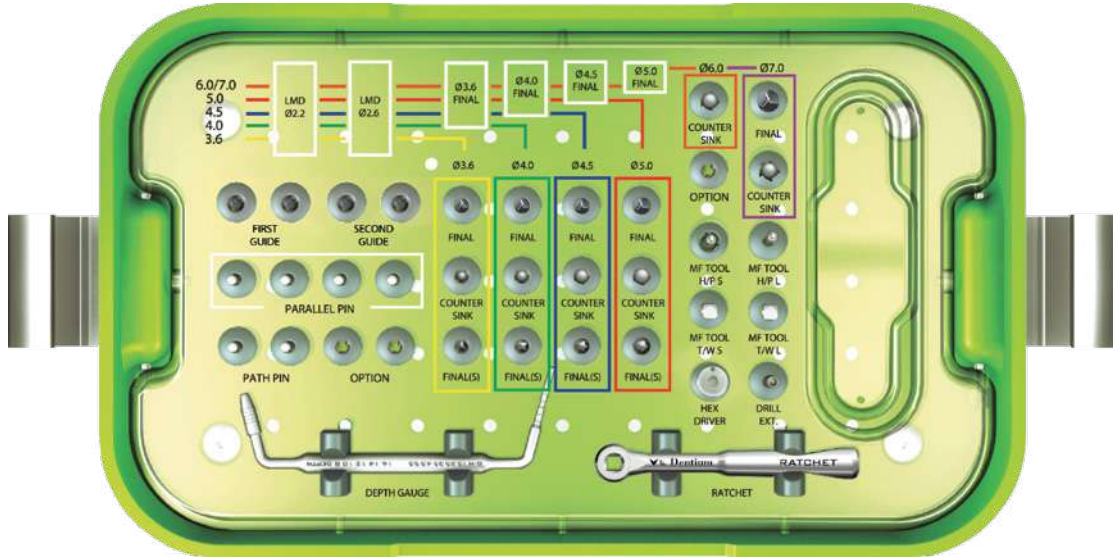























※ Note: It is recommended to keep the torque level at 25~30 N·cm to tighten the magnetic abutment with fixture

# Surgical Kit [Full]



## UXIF

### Kit Contents























- First guide drill
  -  XLD 22 29
  -  XLD 22 35 (Stopper)
- Second guide drill
  -  XLD 26 29
  -  XLD 26 35 (Stopper)
- Final drill (Stopper)
  -  XFD 34 35
  -  XFD 38 35
  -  XFD 43 35
  -  XFD 48 35
- Final drill
  -  XFD 34 29
  -  XFD 38 29
  -  XFD 43 29
  -  XFD 48 29
  -  XFD 58 31
- Countersink
  -  XCS 36 29 SW
  -  XCS 40 29 SW
  -  XCS 45 29 SW
  -  XCS 50 29 SW
  -  XCS 60 29 SW
  -  XCS 70 29 SW
- Parallel pin x 4
  -  XPP 162220T
- Hand-piece adapter
  -  XID 27 H
  -  XID 32 H
- Ratchet adapter
  -  XID 26 W
  -  XID 32 W
- Path pin x 2
  -  XMFPA2
- Hex driver
  -  XHD 26 T
- Drill extension
  -  XDE
- Depth gauge
  -  XDGL
- Ratchet
  -  XRCA1

# Surgical Kit [Standard]



## UXIFN

### Kit Contents

- |                      |   |              |                      |   |              |
|----------------------|---|--------------|----------------------|---|--------------|
| • First guide drill  |  | XLD 22 31    | • Parallel pin       |  | XPP 162220 T |
| • Second guide drill |  | XLD 26 31    |                      |  | XPP 162226 T |
| • Final drill        |  | XFD 34 31    | • Hand-piece adapter |  | XID 30 H     |
|                      |  | XFD 38 31    | • Ratchet adapter    |  | XID 26 W     |
|                      |  | XFD 43 31    | • MF path pin x2     |  | XMFPA2       |
|                      |  | XFD 48 31    | • Hex driver         |  | XHD 26 T     |
|                      |  | XFD 58 31    |                      |  | XHD 25 H     |
| • Countersink        |  | XCS 36 29 SW | • Drill extension    |  | XDE          |
|                      |  | XCS 40 29 SW |                      |   |              |
|                      |  | XCS 45 29 SW | • Ratchet            |  | XRCA1        |
|                      |  | XCS 50 29 SW |                      |   |              |
|                      |  | XCS 60 29 SW |                      |   |              |
|                      |  | XCS 70 29 SW |                      |   |              |

# Drill Stopper Kit

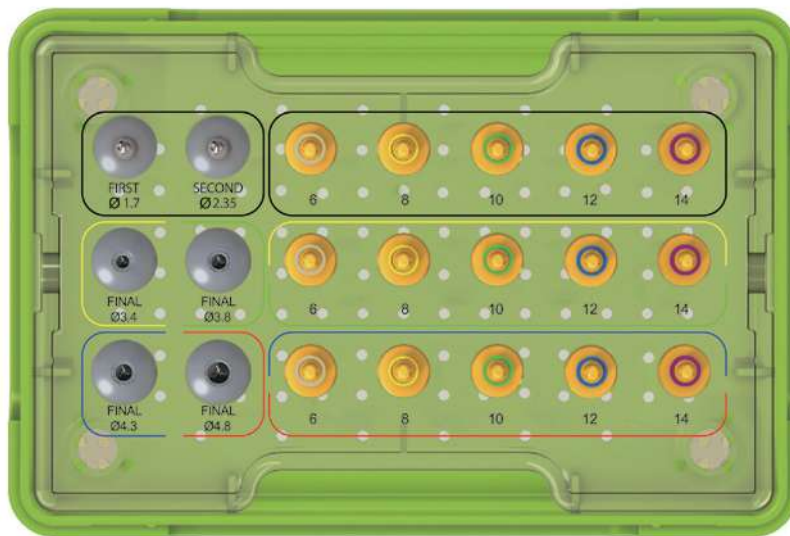

XDS

## Kit Contents

- Guide drill stopper / First, Second



- Stopper-first guide drill, second guide drill



- Final drill stopper / 34, 38



- Stopper-final drill / 34, 38



- Final drill stopper / 43, 48



- Final drill stopper / 43, 48



# Drill



Unit: mm, Scale 1 : 1

## Guide Drill

Diameter	L	Art. No.
Ø1.5	20	XGD 15 20
Ø1.5	28	XGD 15 28

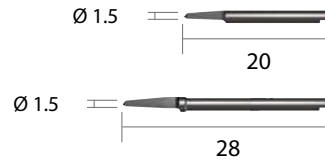

## First Drill

Diameter	L	Art. No.
Ø2.0	29	XFD 20 29
Ø2.0	33	XFD 20 33



## First Guide Drill

Diameter	L	Art. No.
Ø2.2	26	XLD 22 07
Ø2.2	29	XLD 22 29
Ø2.2	31	XLD 22 31
Ø2.2	33	XLD 22 33
Ø2.2	35	XLD 22 35
Ø2.2	41	XLD 22 41

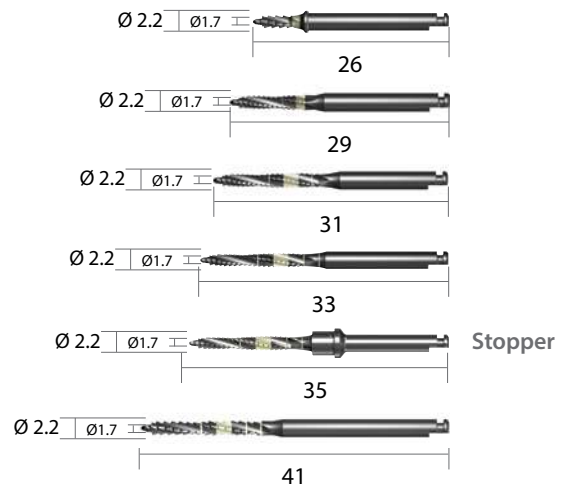

## Second Guide Drill

Diameter	L	Art. No.
Ø2.6	26	XLD 26 07
Ø2.6	29	XLD 26 29
Ø2.6	31	XLD 26 31
Ø2.6	33	XLD 26 33
Ø2.6	35	XLD 26 35
Ø2.6	41	XLD 26 41

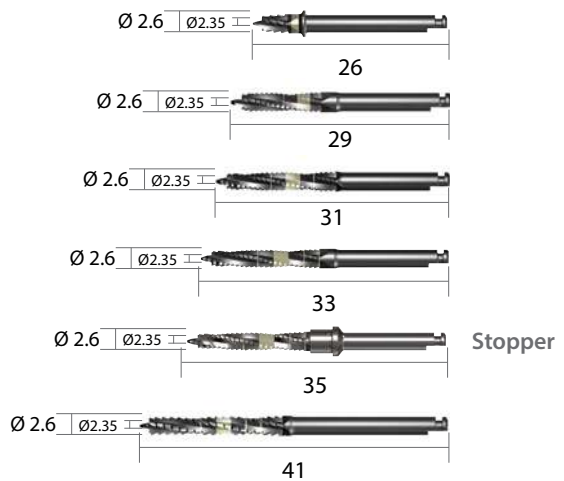

※ Note: Drill speed 1,000rpm, 30~45 N·cm with irrigation

# Drill

Unit: mm, Scale 1 : 1

## Guide Drill

Diameter	L	Art. No.
Ø1.5	20	XGD 15 20
Ø1.5	28	XGD 15 28

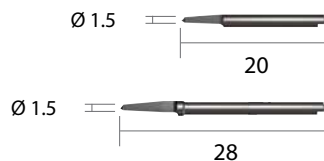

## First Drill

Diameter	L	Art. No.
Ø2.0	29	XFD 20 29
Ø2.0	33	XFD 20 33

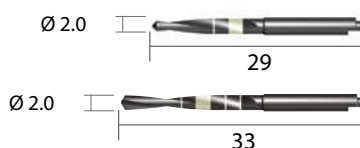

## First Guide Drill

Diameter	L	Art. No.
Ø2.2	26	XLD 22 07
Ø2.2	29	XLD 22 29
Ø2.2	31	XLD 22 31
Ø2.2	33	XLD 22 33
Ø2.2	35	XLD 22 35
Ø2.2	41	XLD 22 41

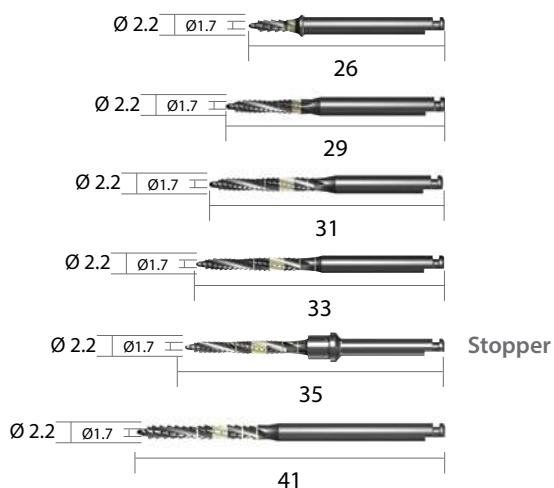

## Second Guide Drill

Diameter	L	Art. No.
Ø2.6	26	XLD 26 07
Ø2.6	29	XLD 26 29
Ø2.6	31	XLD 26 31
Ø2.6	33	XLD 26 33
Ø2.6	35	XLD 26 35
Ø2.6	41	XLD 26 41

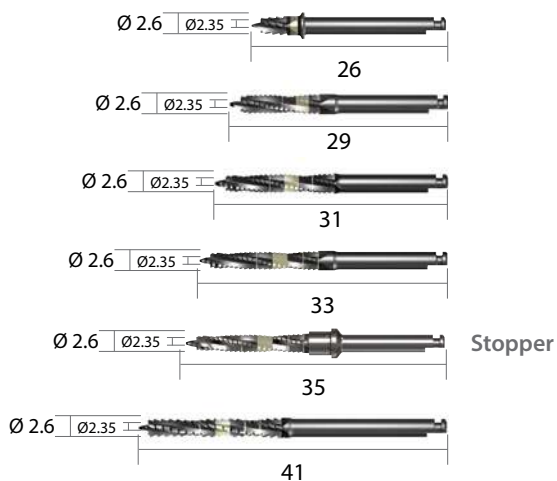

※ Note: Drill speed 1,000rpm, 30~45 N-cm with irrigation



# Drill

Unit: mm, Scale 1 : 1

## Final Drill | Length-33mm

Diameter	L	Art. No.
Ø2.9	33	XFD 34 33
Ø3.35	33	XFD 38 33
Ø3.85	33	XFD 43 33
Ø4.4	33	XFD 48 33

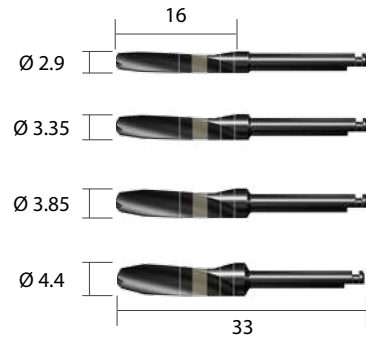

## Final Drill | Length-35mm | Stopper

Diameter	L	Art. No.
Ø2.9	35	XFD 34 35
Ø3.35	35	XFD 38 35
Ø3.85	35	XFD 43 35
Ø4.4	35	XFD 48 35

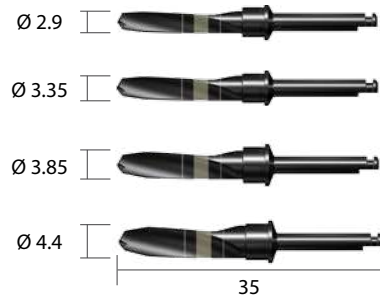

## Final Drill | Length-41mm

Diameter	L	Art. No.
Ø2.9	41	XFD 34 41
Ø3.35	41	XFD 38 41
Ø3.85	41	XFD 43 41
Ø4.4	41	XFD 48 41

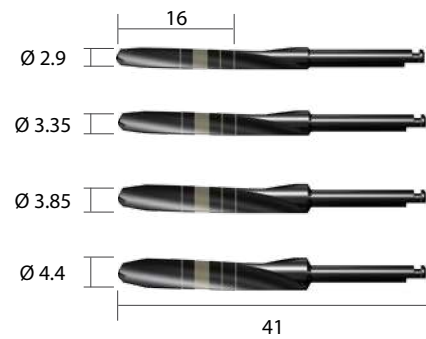

※ Note: Drill speed 1,000rpm, 30~45 N·cm with irrigation

# Drill

Unit: mm, Scale 1 : 1

## Harvest Drill | Length-35mm | Stopper

Diameter	L	Art. No.
Ø2.85	35	XFH 34 35
Ø3.3	35	XFH 38 35
Ø3.85	35	XFH 43 35
Ø4.4	35	XFH 48 35

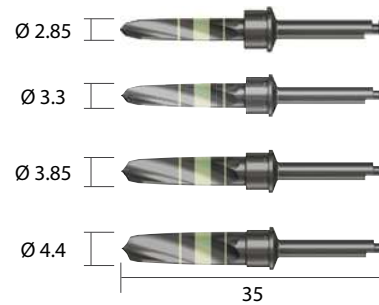

## Countersink

Diameter	L	Art. No.
Ø3.6	29	XCS 36 29 SW
Ø4.0	29	XCS 40 29 SW
Ø4.5	29	XCS 45 29 SW
Ø5.0	29	XCS 50 29 SW
Ø6.0	27	XCS 60 29 SW
Ø7.0	27	XCS 70 29 SW

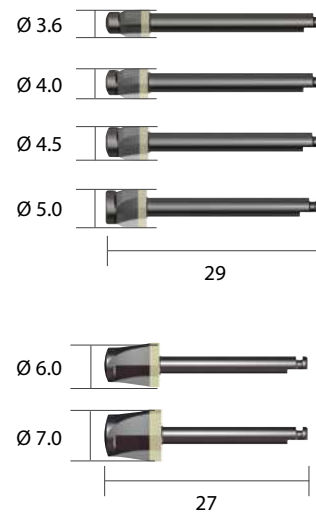

## Round Bur

Diameter	L	Art. No.
Ø2.0	33	XRB 20 33
Ø3.0	33	XRB 30 33



※ Note: Drill speed 1,000rpm, 30~45 N·cm with irrigation

# Stopper

Unit: mm, Scale 1 : 1

## Stopper | For first guide drill, second guide drill

Drilling Depth	L	Art. No.
14	4.6	XLDST 14
12	6.6	XLDST 12
10	8.6	XLDST 10
08	10.6	XLDST 08
06	12.6	XLDST 06
04	14.6	XLDST 04
02	16.6	XLDST 02



## Stopper | For final drill 3435, 3835

Drilling Depth	L	Art. No.
14	4.6	XFDST 14
12	6.6	XFDST 12
10	8.6	XFDST 10
08	10.6	XFDST 08
06	12.6	XFDST 06
04	14.6	XFDST 04
02	16.6	XFDST 02

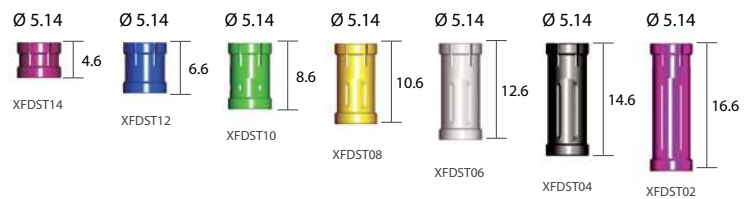

## Stopper | For final drill 4335, 4835

Drilling Depth	L	Art. No.
14	4.6	XFDST 14L
12	6.6	XFDST 12L
10	8.6	XFDST 10L
08	10.6	XFDST 08L
06	12.6	XFDST 06L
04	14.6	XFDST 04L
02	16.6	XFDST 02L



# Instrument

Unit: mm, Scale 1 : 1

## Adapter | Hex 1.28mm

Type	L	Art. No.
Hand-piece	27	XID 27 H
	30	XID 30 H
	32	XID 32 H
Ratchet	24	XID 24 W
	26	XID 26 W
	29	XID 29 W
	32	XID 32 W

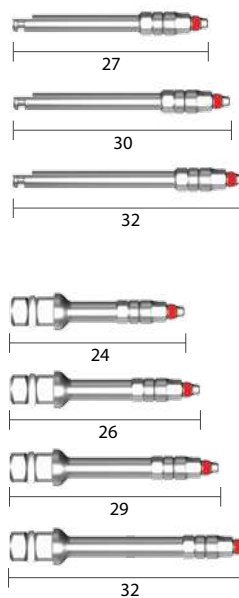

## Parallel Pin | For first guide drill, second guide drill

Diameter	Art. No.
Ø1.6	XPP 162212
Ø1.6	XPP 162220T
Ø1.6	XPP 162226T

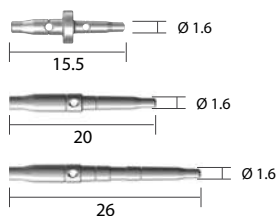

## Path Pin

L	Art. No.
18.6	XMFP A2



# Instrument

Unit: mm, Scale 1 : 1

## Hex Driver | Hex 1.28mm

Type	L	Art. No.
Hand-piece	25	XHD 25 H
Ratchet	21	XHD 21 W
	25	XHD 25 W
	27	XHD 27 W
Manual	26	XHD 26 T
	30	XHD 30 T

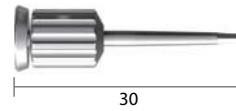
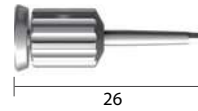
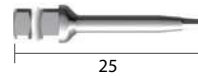
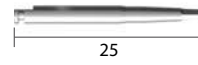

## Slot Driver

Type	Art. No.
Ratchet	SDA 17 R
	SDA 25 R

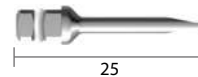

## Drill Extension

XDE
-----

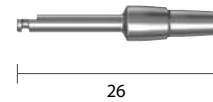

## Driver | Manual

Type	Art. No.
Manual	XHDHT



# Instrument

Unit: mm

## Adapter | For screw & ball abutment | Scale 1 : 1

Type	Art. No.
Hand-piece	XMAA1
Ratchet	XMA21W

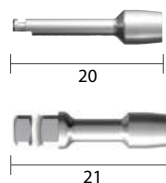

## Adapter | For mini ball abutment | Scale 1 : 1

IPST21W
---------



## Ratchet

XRCA1
-------



## Torque Wrench | Scale 1 : 0.7

XNTW
------



## Depth Gauge

XDGL
------

※ Note: One side of Depth Gauge measures the osteotomy depth and the other side measures the gingival height from the top of the implant

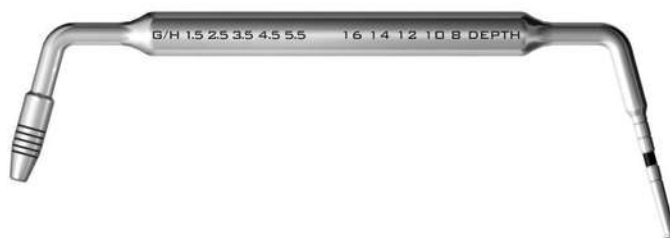

## Tissue Punch | Scale 1 : 1

XTS40
-------



Punching size : Ø4.0

# DASK [Dentium Advanced Sinus Kit]

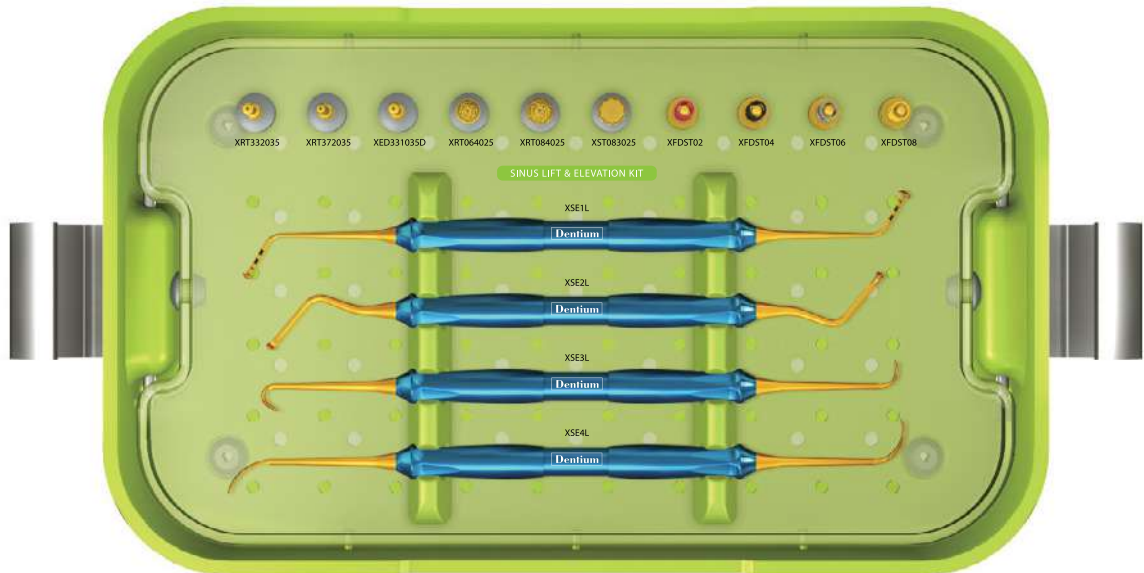

DASK

## Kit Contents

- DASK drill



- Stopper



- Sinus elevation instrument





# Sinus Bur Kit / Sinus Kit



SDK

## Kit Contents

- DASK drill



- Stopper



## Sinus Kit

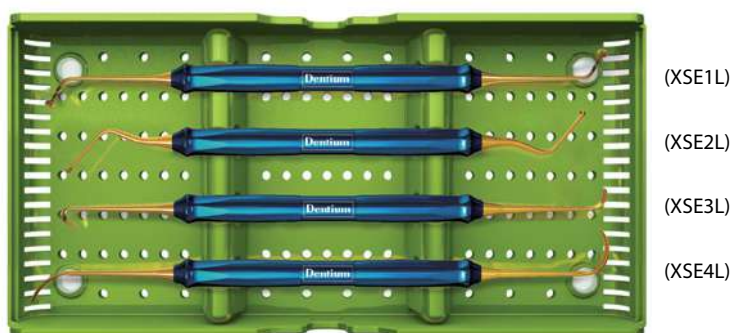

XSKL

# DASK / Sinus Bur Kit / Sinus Kit

Unit: mm

## DASK Drill | Scale 1 : 1.2

Type	DASK Drill #	Art.No.
<b>Crestal Approach</b>	DASK Drill #1	XRT 332035
	DASK Drill #2	XRT 372035
	DASK Drill #3	XED 331035D
<b>Lateral Approach</b>	DASK Drill #4	XRT 064025
	DASK Drill #5	XRT 084025
	DASK Drill #6	XST 083025

Note: Drill speed 800 to 1,200rpm, 30~45N-cm with irrigation

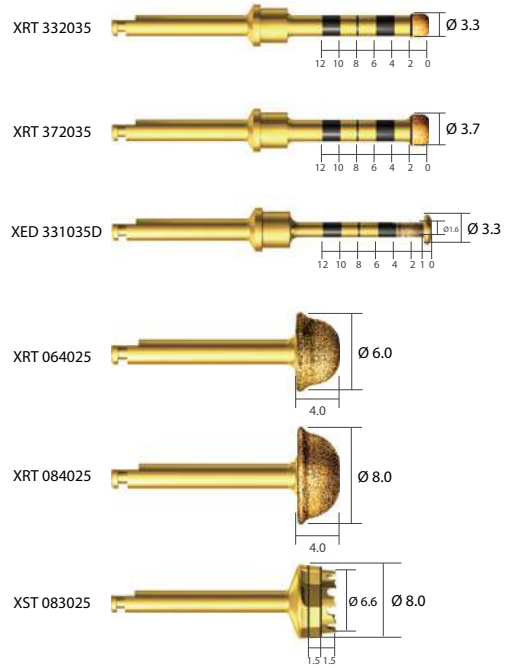

## Stopper | For XRT332035, XRT372035, XED331035D | Scale 1 : 1

Drilling Depth	L	Art.No.
<b>08</b>	10.6	XFDST 08
<b>06</b>	12.6	XFDST 06
<b>04</b>	14.6	XFDST 04
<b>02</b>	16.6	XFDST 02



## Sinus Elevation Instrument | Scale 1 : 0.45

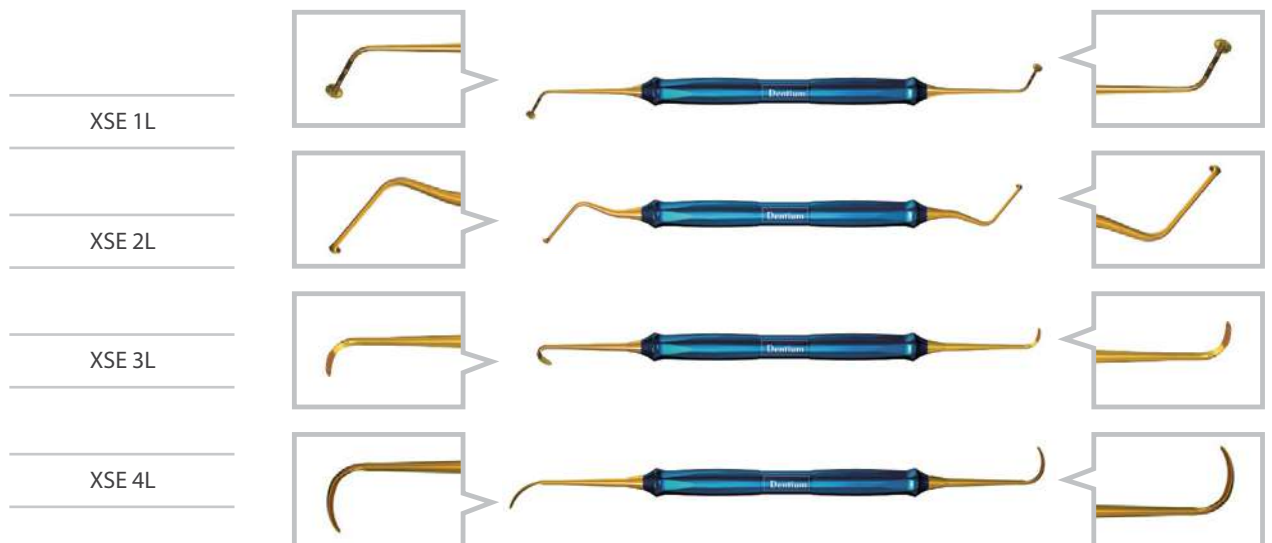

# Osteotome Kit

Unit: mm

## Osteotome Kit

Osteotome compresses the bone laterally, providing denser bony interface rather than removing valuable bone from the surgical site

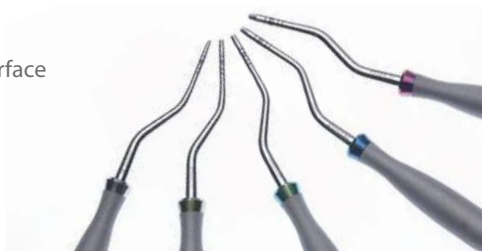

### Osteotome | Final drill type | Scale 1 : 0.4

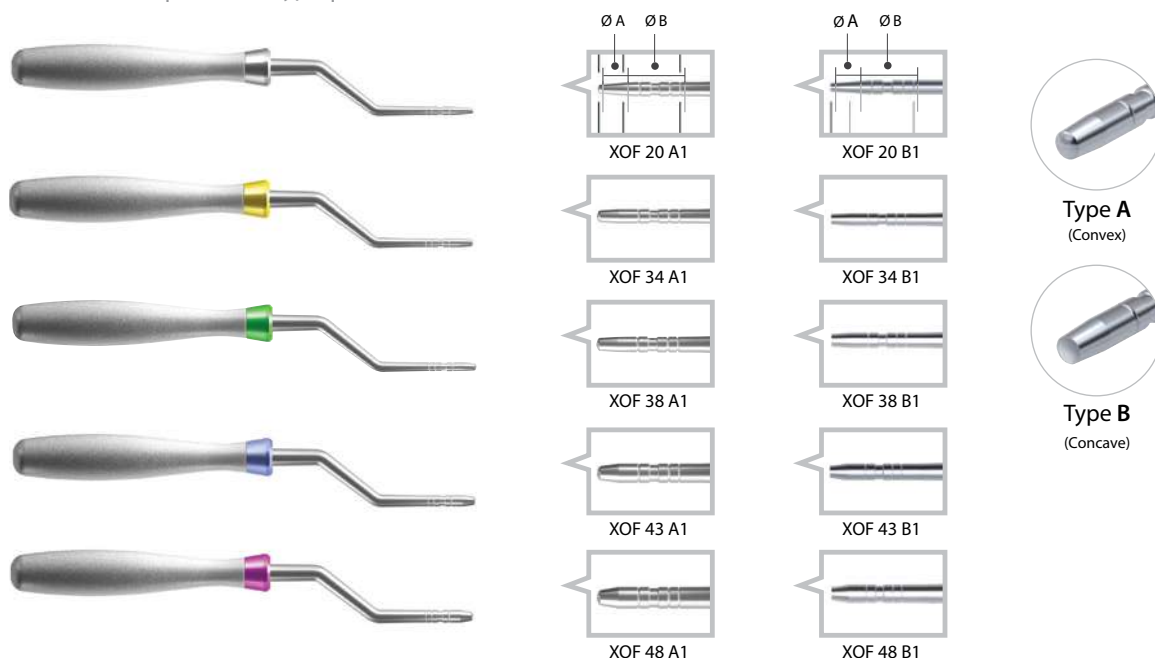

## Osteotome Kit

Type	Art.No.	Ø A	Ø B
<b>XOFK</b> Type A (Convex)	XOF 20 A1	Ø 1.7	Ø 2.8
	XOF 34 A1	Ø 2.3	Ø 2.8
	XOF 38 A1	Ø 2.7	Ø 3.2
	XOF 43 A1	Ø 2.8	Ø 3.8
	XOF 48 A1	Ø 3.0	Ø 4.3
<b>XOFBK</b> Type B (Concave)	XOF 20 B1	Ø 1.7	Ø 2.8
	XOF 34 B1	Ø 2.3	Ø 2.8
	XOF 38 B1	Ø 2.7	Ø 3.2
	XOF 43 B1	Ø 2.8	Ø 3.8
	XOF 48 B1	Ø 3.0	Ø 4.3

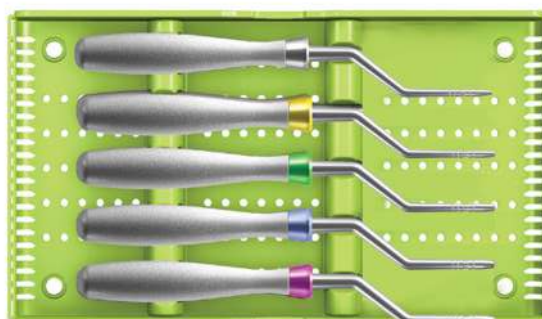

XOFK (Type A)

XOFBK (Type B)

# Trephine Kit

Unit: mm

## Trephine Bur

- Excellent fine cutting
- Strong engagement when attaching the trephine to cortical bone
- Cut-outs facilitates ease of harvest retrieval
- 5 scale marks on the Trephine drill from 2mm to 10mm
- Easy harvesting

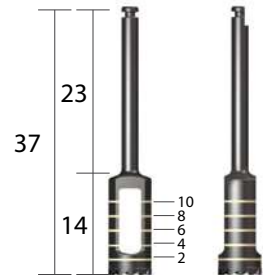

## Trephine Bur | Scale 1 : 0.5

Outer Diameter	Inner Diameter	Art. No.
Ø3.0	Ø2.3	XTP 24 03
Ø4.0	Ø3.3	XTP 34 04
Ø5.0	Ø4.2	XTP 44 05
Ø6.0	Ø5.2	XTP 54 06
Ø7.0	Ø6.1	XTP 64 07
Ø8.0	Ø7.1	XTP 74 08
Ø9.0	Ø8.0	XTP 84 09
Ø10.0	Ø9.0	XTP 94 10

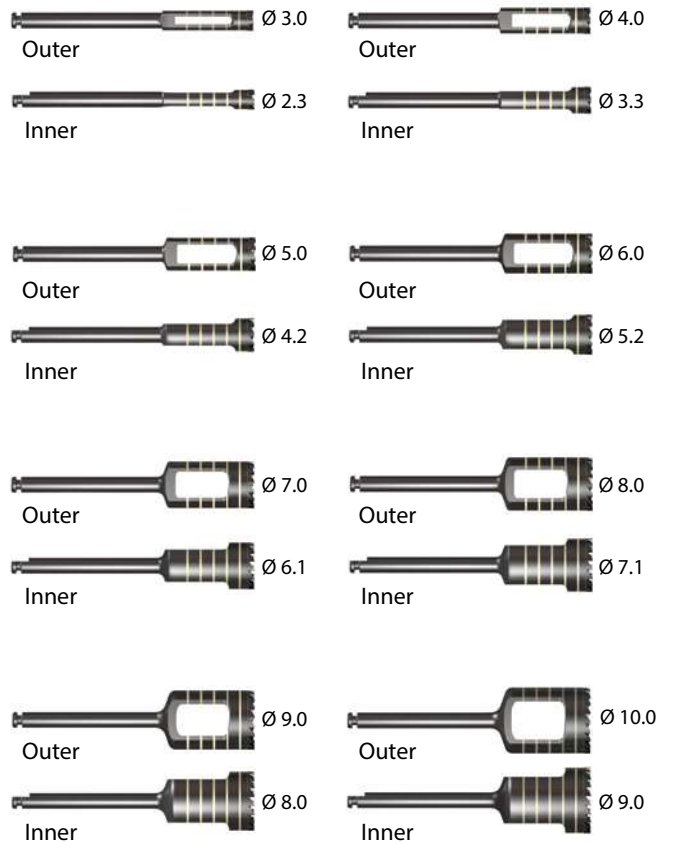

## Trephine Kit

XIT

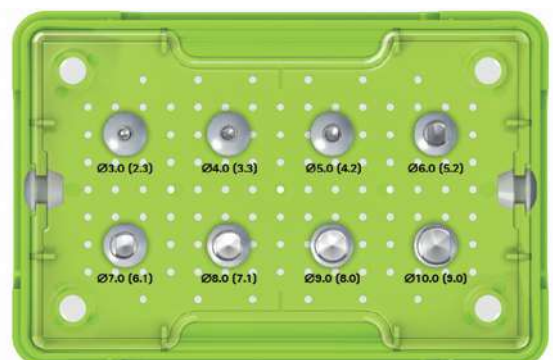

# Prosthetic Kit

Unit: mm

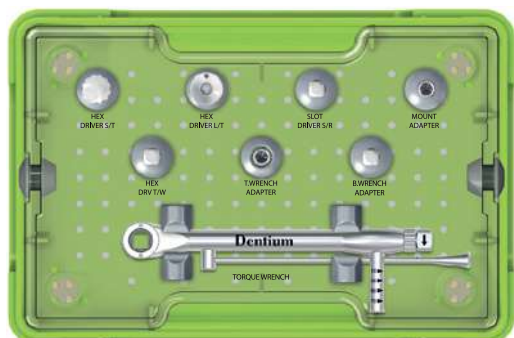

XIP

Hex Driver S/T | Scale 1 : 1

XHD 15



Hex Driver L/T | Scale 1 : 1

XHD 30 T



Slot Driver | Scale 1 : 1

SDA 25 R



Mount Adapter | Scale 1 : 1

XMAA 1



Hex Driver T/W | Scale 1 : 1

XHD 25 W



T/W Adapter | Scale 1 : 1

XMA 21 W



Mini Ball Adapter | Scale 1 : 1

IPST 21 W



Torque Wrench | Scale 1 : 0.5

XNTW



# Planning Kit

Unit: mm, Scale 1 : 1



XPK

## Kit Contents

### Diameter Ø4.5 | Combi & Dual abutment

G/H	Art.No.
1.5	PDAB 45 15
2.5	PDAB 45 25
3.5	PDAB 45 35
4.5	PDAB 45 45
5.5	PDAB 45 55



### Diameter Ø5.5 | Combi & Dual abutment

G/H	Art.No.
1.5	PDAB 55 15
2.5	PDAB 55 25
3.5	PDAB 55 35
4.5	PDAB 55 45
5.5	PDAB 55 55

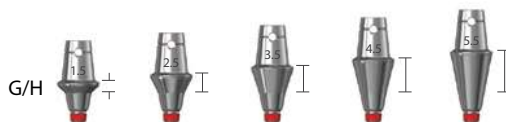

### Diameter Ø6.5 | Combi & Dual abutment

G/H	Art.No.
1.5	PDAB 65 15
2.5	PDAB 65 25
3.5	PDAB 65 35
4.5	PDAB 65 45
5.5	PDAB 65 55



### Angled 15° | Angled abutment

Diameter	G/H	Art.No.
Ø4.5	2.0	PAAB 15 45 20
Ø4.5	4.0	PAAB 15 45 40
Ø5.5	2.0	PAAB 15 55 20
Ø5.5	4.0	PAAB 15 55 40



### Angled 25° | Angled abutment

Diameter	G/H	Art.No.
Ø4.5	2.0	PAAB 25 45 20
Ø4.5	4.0	PAAB 25 45 40
Ø5.5	2.0	PAAB 25 55 20
Ø5.5	4.0	PAAB 25 55 40



# Prosthetic and Laboratory Instrument

Unit: mm

## Hex Driver | Hex 1.28 mm | Scale 1 : 1

L	Art. No.
13	XHD 13
15	XHD 15
21	XHD 21
28	XHD 28

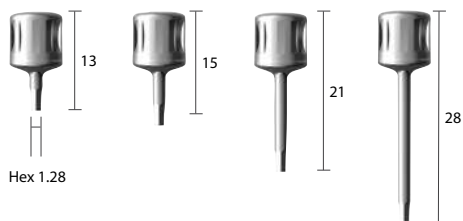

## Reamer Guide for Combi/Dual Abutment | Scale 1 : 1

Diameter	Art. No.
Ø4.5	CRG 45 L
Ø5.5	CRG 55 L
Ø6.5	CRG 65 L



## Reamer Guide for Screw Abutment | Scale 1 : 1

Type	Art. No.
Bridge	SRG BL
Single	SRG SL





# Prosthetic and Laboratory Instrument

Unit: mm

**Reamer Handle** | Scale 1 : 0.5

CRH



**Hand Wrench** | Scale 1 : 1

XHW



**Reamer (Combi/Dual Abutment)** | Scale 1 : 1

CRM



**Reamer (Screw Abutment)** | Scale 1 : 1

SRM



# Help Kit

Unit: mm

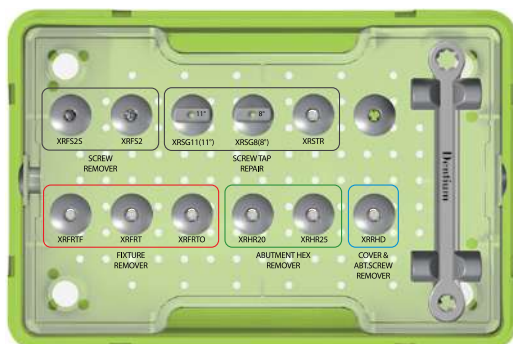

XIH

## Cover & Abutment Screw Remover

| Scale 1 : 1

L	Art. No
25	XRRHD



## Abutment Hex Remover | Scale 1 : 1

L	Art. No
20	XRHR20
25	XRHR25

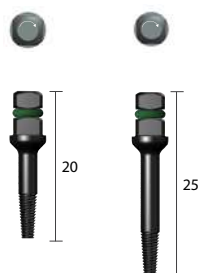

## Screw Remover | Scale 1 : 1

L	Art. No
25	XRFS25
33	XRFS2

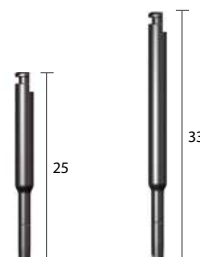

## Fixture Remover | Scale 1 : 1

Type	Art. No
Remover	XRFRT
	XRFaRTF
	XRFRTO
Wrench	XRFRW



## Screw Tap Repair | Scale 1 : 1

Type	Art. No
Tap	XRSTR
11° Guide	XRSG11
8° Guide	XRSG8

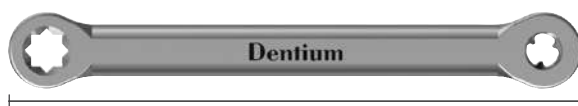
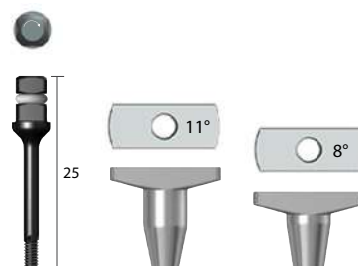

75

**Dentium**  
For Dentists By Dentists

# DENTIUM LONG-TERM CLINICAL DATA

2002

2003

2004

2005

2006

2007

2008

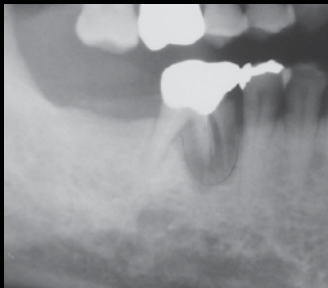

2002. 05. 17  
Pre-op



2002. 09. 04  
Post-op



2003. 03. 15  
Final prosthesis

# Dentium

For Dentists By Dentists

2009

2010

2011

2012

2013

2014

2015

11 YEARS



2008. 04. 14  
5 years

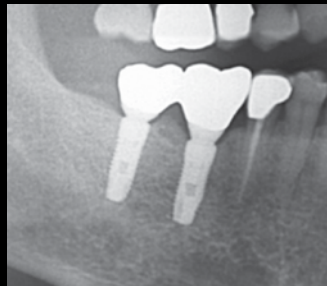

2013. 12. 05  
11 years

over  
**10** years  
of Long  
term  
data

OVER A **DECADE** OF  
COMMITMENT TO  
THE **BEST PRODUCTS**  
FOR DENTISTS AND  
PATIENTS

**Dentium**  
For Dentists By Dentists

**Dentium**  
For Dentists By Dentists

# Implantium II

## Product Catalog

**Dentium**  
For Dentists By Dentists

Specifications are subject to change without any notice.  
Some products listed in this catalog are not available in the market due to pending approval.

**HEAD OFFICE**

6F, 29, Teheran-ro 87-gil, Gangnam-gu, Seoul, Korea (135-879) Tel +82-2-555-3750 Fax +82-2-501-9560

**HOME PAGE**

[www.dentium.co.kr](http://www.dentium.co.kr)

I2PC-1511 [Rev.1]